

Hold	Skive	Asger Kristensen	
1	1		
15m	Aalborg Skyttekreds	V1	
28.02.2014	Nordjysk Mesterskab 2014, senio	Aalborg Skyttekreds	
Prøve		1: 10.3	↓
		2: 10.4	↘
		3: 10.3	↑
		4: 10.0	↗
		5: 10.8x	↙
		6: 10.6x	↖
		Serie	60.0
		Total	0.0
20 Skud		1: 10.7x	↓
		2: 9.7	←
		3: 10.1	↙
		4: 10.3	←
		5: 10.2	↙
		6: 9.9	→
		7: 10.3	↑
		8: 10.6x	↗
		9: 10.5	←
		10: 10.5x	↗
		Serie	98.0
		Total	98.0
20 Skud		11: 10.3	↙
		12: 10.4	↑
		13: 9.9	←
		14: 10.5x	↓
		15: 9.9	↘
		16: 10.7x	↓
		17: 10.0	↗
		18: 10.0	←
		19: 9.9	→
		20: 10.0	↗
		Serie	97.0
		Total	195.0

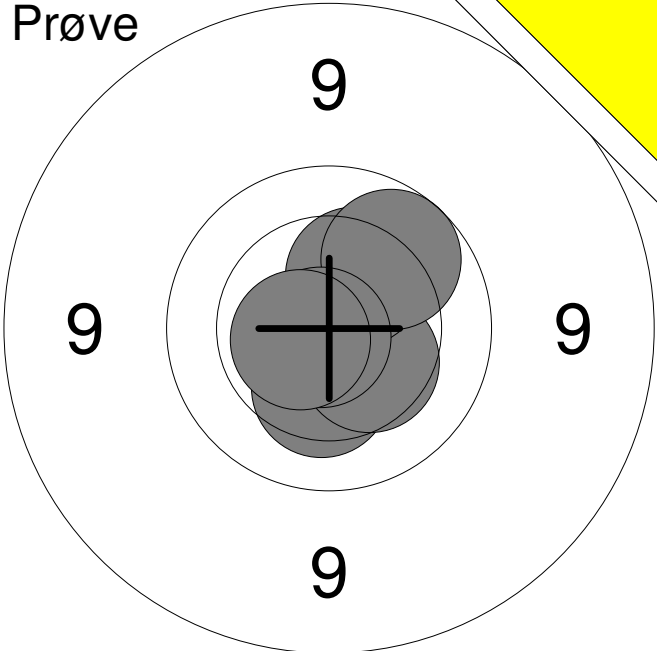

1: 10.1 ↙	6: 10.1 →	Serie	95
2: 9.2 ↓	7: 9.9 ↗		
3: 9.6 ↖	8: 10.4 ↓	Total	0
4: 10.5 ←	9: 10.4 ↗		
5: 9.9 ↓	10: 9.9 →		

11: 10.4 ↙		Serie	10
		Total	0

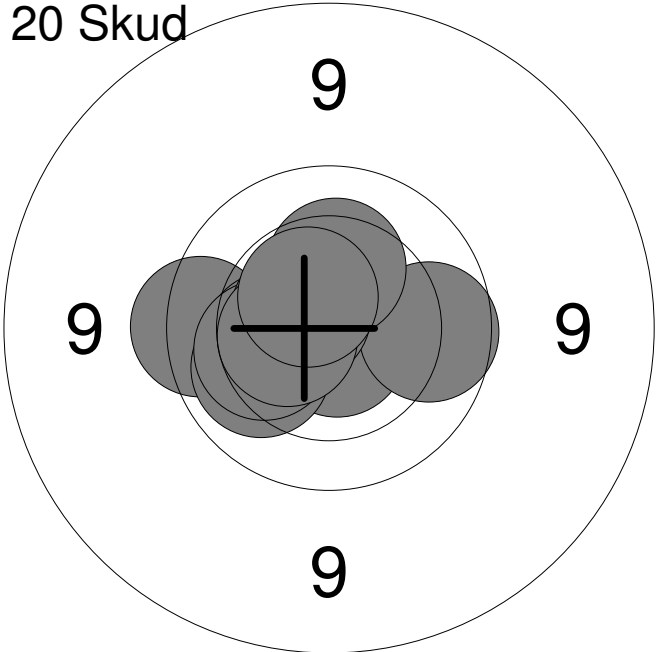
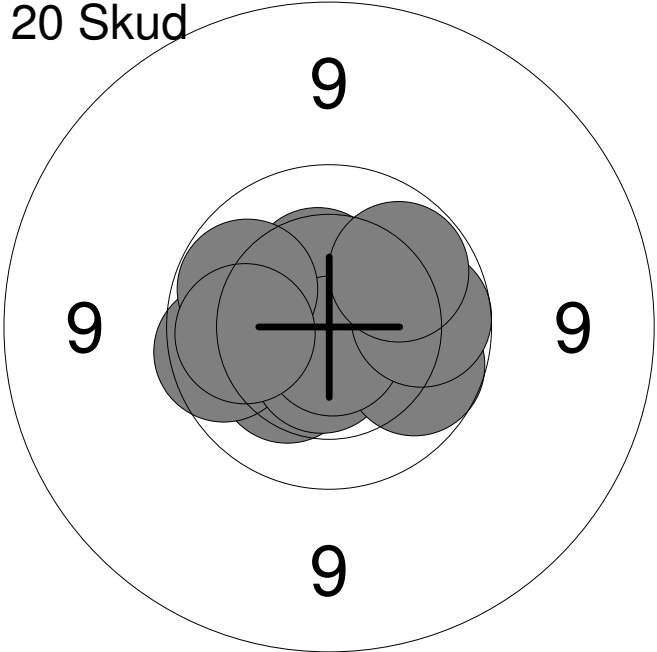
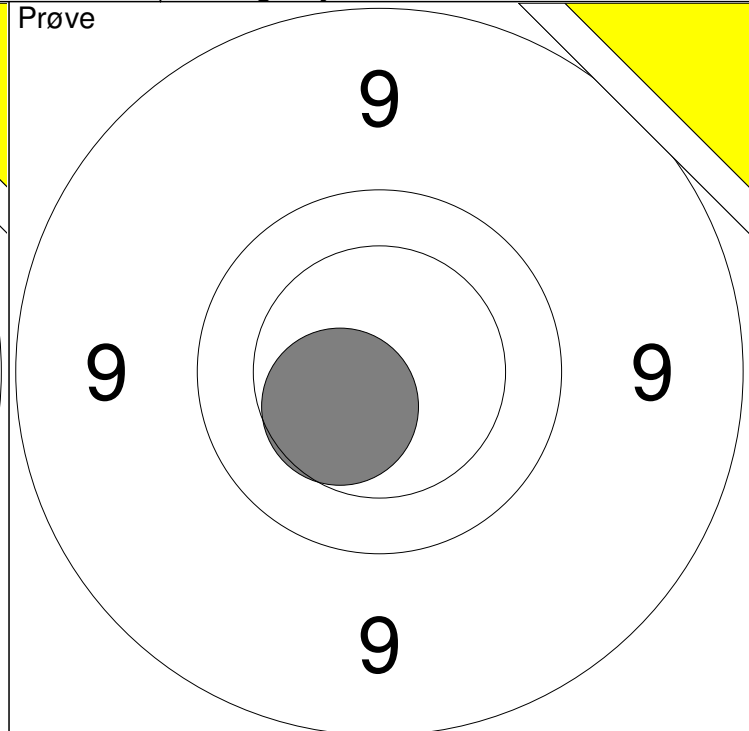
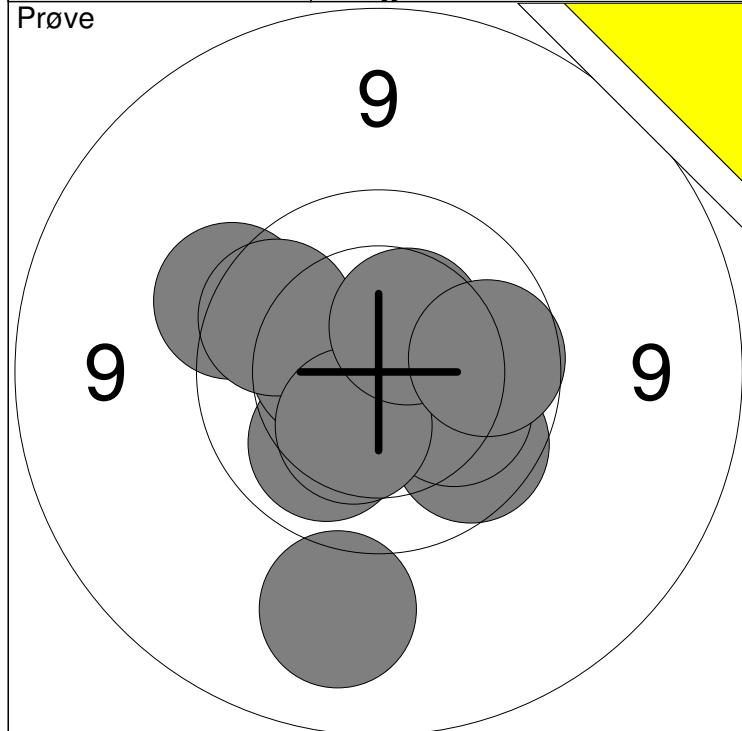
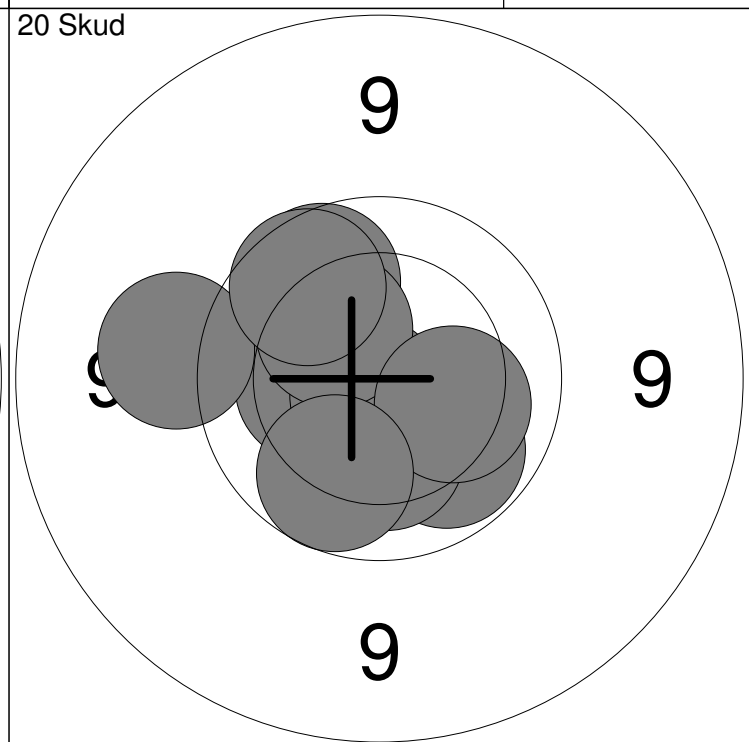
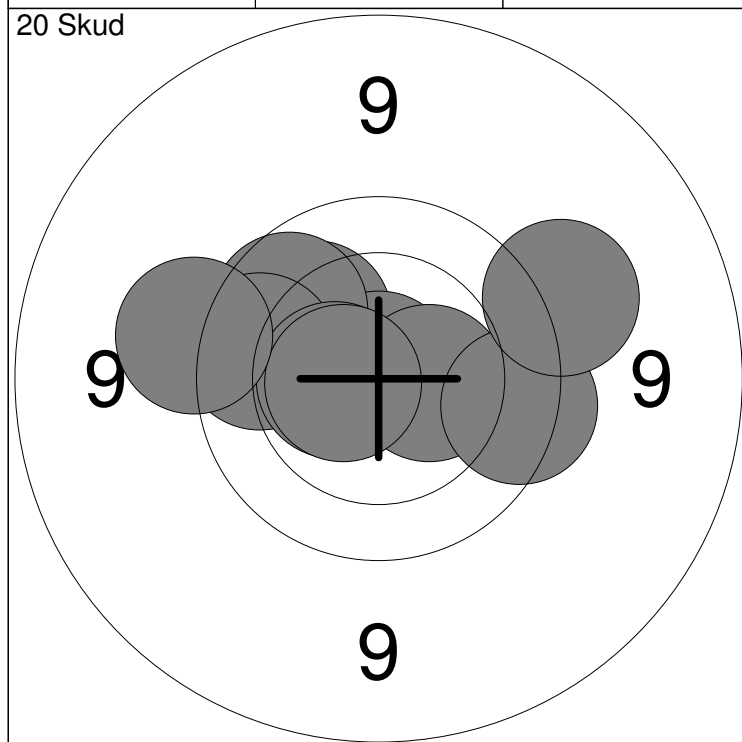

1: 10.1 ↗	6: 10.5x ←	Serie	95
2: 10.9x ↑	7: 10.6x ←		
3: 10.5 →	8: 9.7 →	Total	95
4: 9.9 ↗	9: 9.5 ←		
5: 9.9 ←	10: 9.4 →		

11: 10.3 ←	16: 9.4 ←	Serie	96
12: 10.0 ↓	17: 10.3 ↗		
13: 10.8x ↙	18: 9.9 ↗	Total	191
14: 9.9 ↗	19: 10.2 →		
15: 10.2 ↓	20: 9.9 ↓		

Hold	Skive	Knud Jensen	
1	6		
15m	Frederikshavn Skyttekreds	V1	
28.02.2014	Nordjysk Mesterskab 2014, senio	Aalborg Skyttekreds	
Prøve		1: 10.8x	↖
		2: 9.9	↗
		3: 10.8x	↖
		4: 10.8x	↙
		5: 10.4	↗
		6: 10.8x	↙
		Serie	59.0
		Total	0.0
20 Skud		1: 10.1	↓
		2: 10.5x	↗
		3: 10.6x	↗
		4: 10.8x	↖
		5: 10.1	↗
		6: 10.3	↗
		7: 10.8x	↗
		8: 10.6x	→
		9: 10.1	↓
		10: 10.2	→
		Serie	100.0
		Total	100.0
20 Skud		11: 10.0	↖
		12: 10.3	↓
		13: 10.7x	↗
		14: 10.9x	→
		15: 10.3	↖
		16: 10.6x	↙
		17: 10.5	↖
		18: 10.4	↓
		19: 10.6x	↖
		20: 10.5x	↓
		Serie	100.0
		Total	200.0

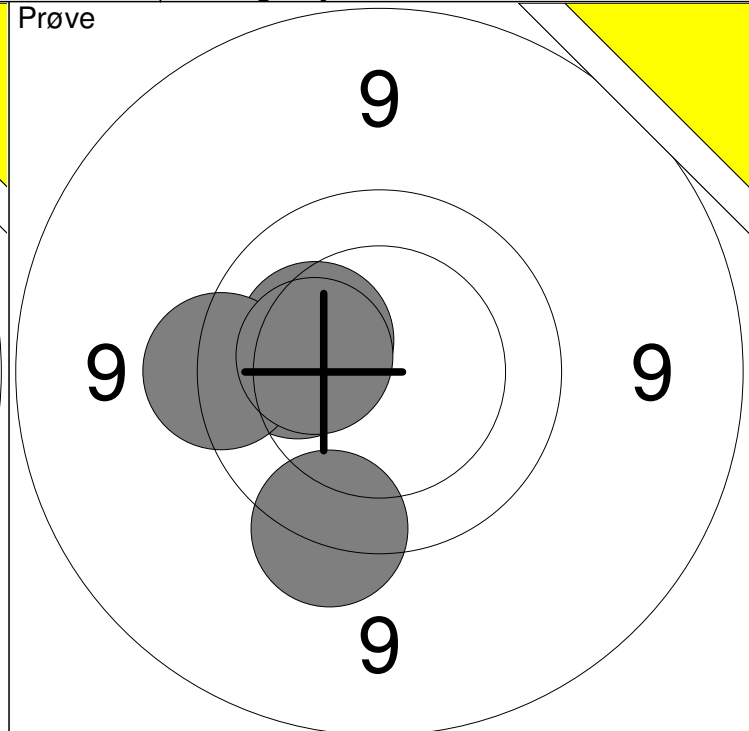
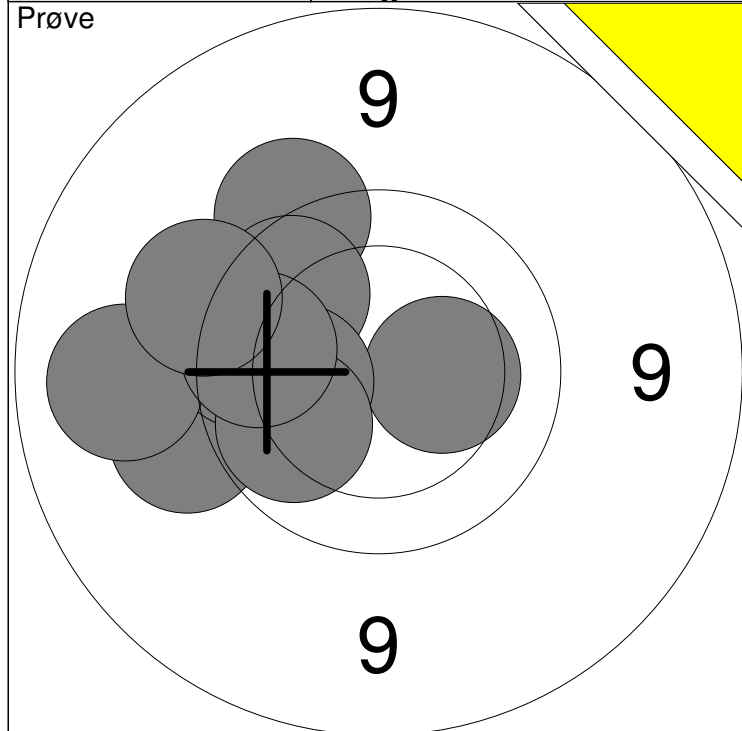

1: 10.3 →	6: 10.1 ←	Serie	93
2: 9.5 ↗	7: 9.1 ←		
3: 9.9 ↗	8: 10.0 ↙	Total	0
4: 9.4 ←	9: 9.8 ←		
5: 9.8 ←	10: 9.5 ↖		

11: 10.2 ←	Serie	48
12: 10.3 ↗		
13: 9.6 ←	Total	0
14: 9.6 ↓		
15: 10.3 ←		

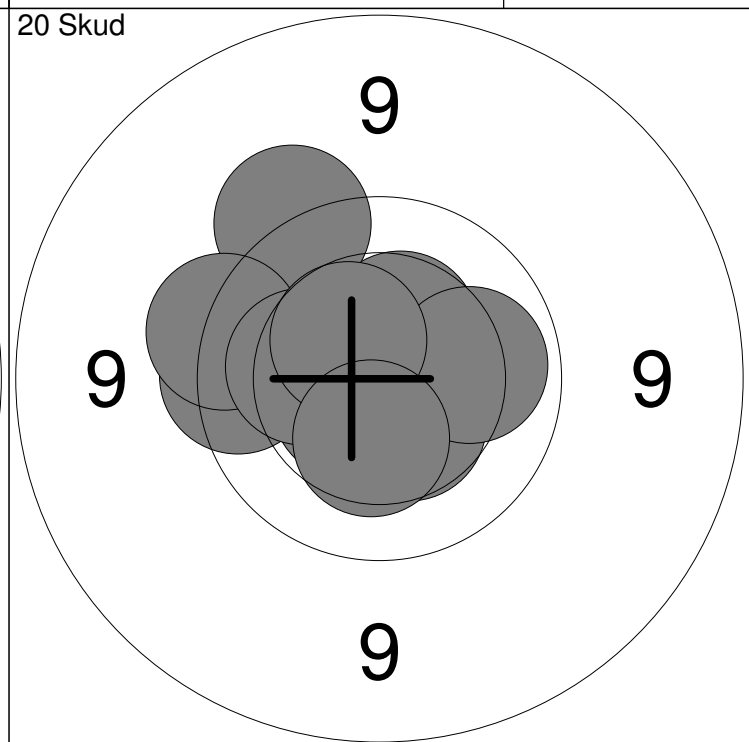
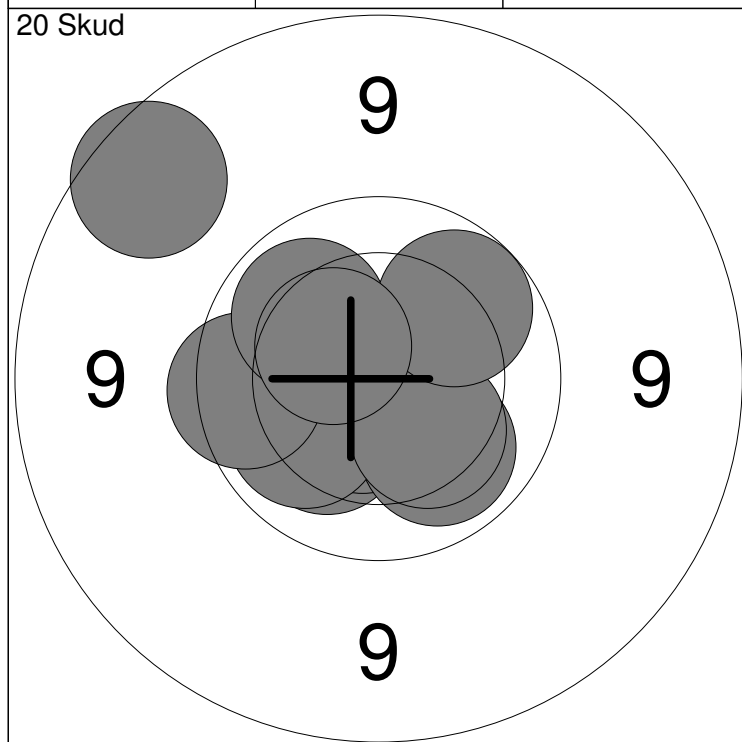

1: 10.2 ↙	6: 8.9 ↗	Serie	97
2: 10.6x ↓	7: 10.3 ↓		
3: 10.1 ↓	8: 10.1 ↗	Total	97
4: 10.1 ←	9: 10.0 ↗		
5: 9.8 ←	10: 10.4 ↗		

11: 10.4 ↗	16: 9.6 ←	Serie	97
12: 10.4 ↓	17: 10.1 →		
13: 9.7 ←	18: 10.2 ←	Total	194
14: 10.6x ↙	19: 10.5 ↗		
15: 9.5 ↗	20: 10.4 ↓		

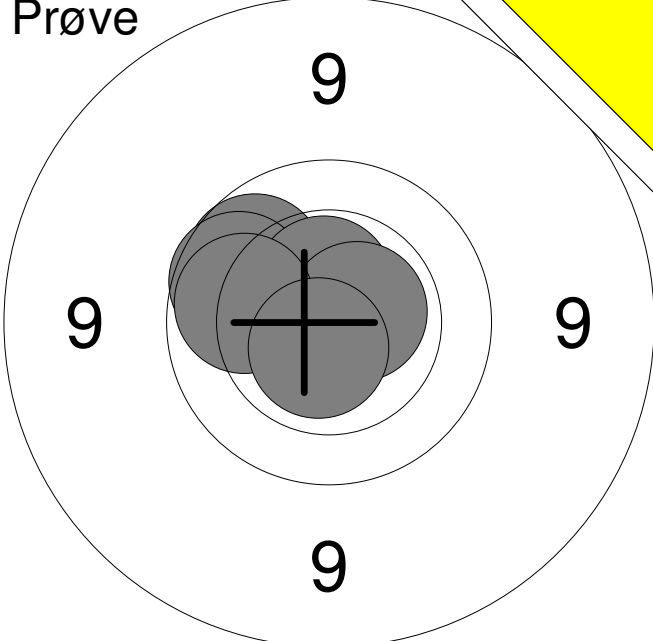
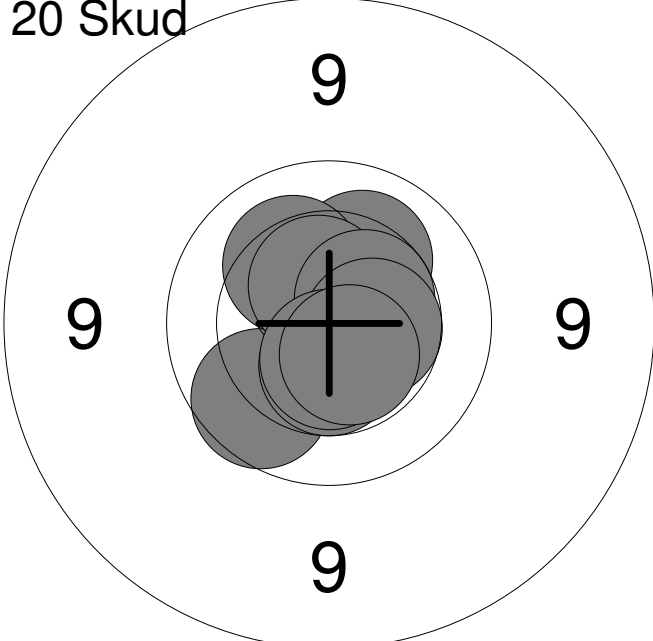
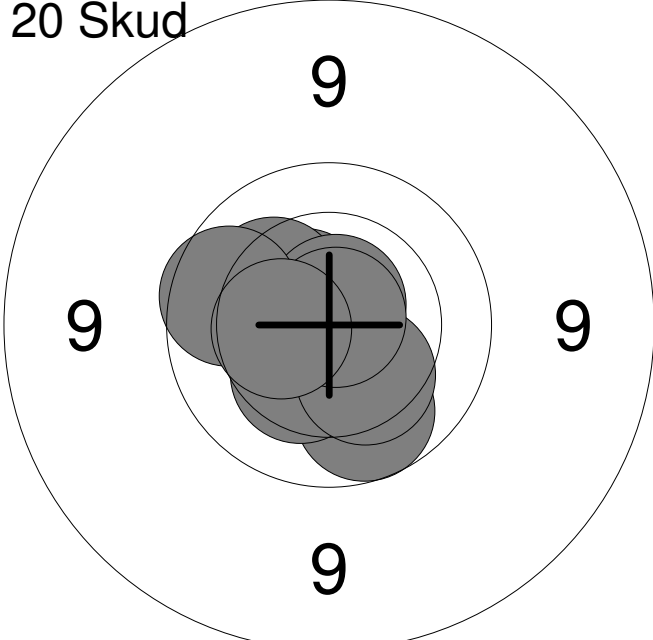
Hold	Skive	Knud Jensen	
2	4		
15m	Frederikshavn Skyttekreds	MV1	
28.02.2014	Nordjysk Mesterskab 2014, senio	Aalborg Skyttekreds	
Prøve		1: 9.9 ↗	
		2: 9.9 ↗	
		3: 10.6x ↑	
		4: 10.6x ↑	
		5: 10.6x →	
		6: 10.0 ←	
		7: 10.7x ↓	
		Serie	68.0
		Total	0.0
20 Skud		1: 9.9 ↙	
		2: 10.2 ↗	
		3: 10.6x ↑	
		4: 10.2 ↗	
		5: 10.5x ↑	
		6: 10.5 →	
		7: 10.5 ↓	
		8: 10.5 →	
		9: 10.6x ↓	
		10: 10.5x ↓	
		Serie	99.0
		Total	99.0
20 Skud		11: 10.6x ↙	
		12: 10.5x ↗	
		13: 9.9 ↓	
		14: 10.3 ↙	
		15: 10.3 ↓	
		16: 10.2 ↗	
		17: 10.7x ↑	
		18: 9.9 ←	
		19: 10.8x ↗	
		20: 10.4 ←	
		Serie	98.0
		Total	197.0

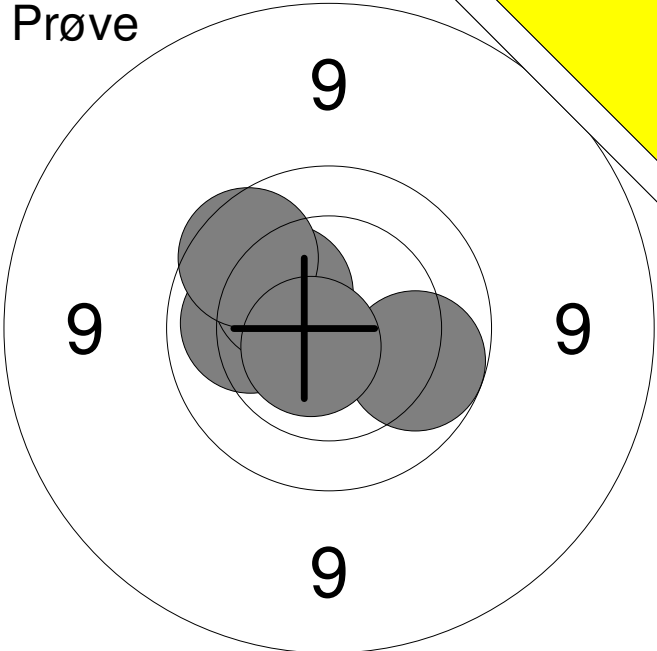
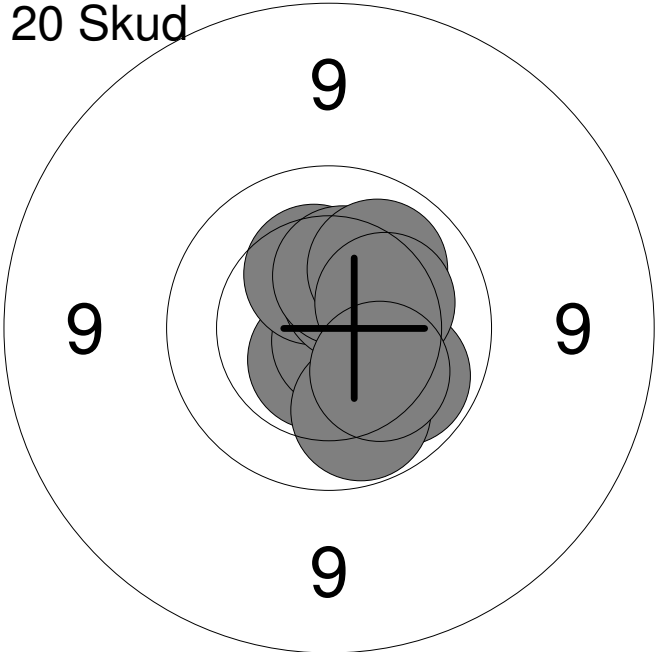
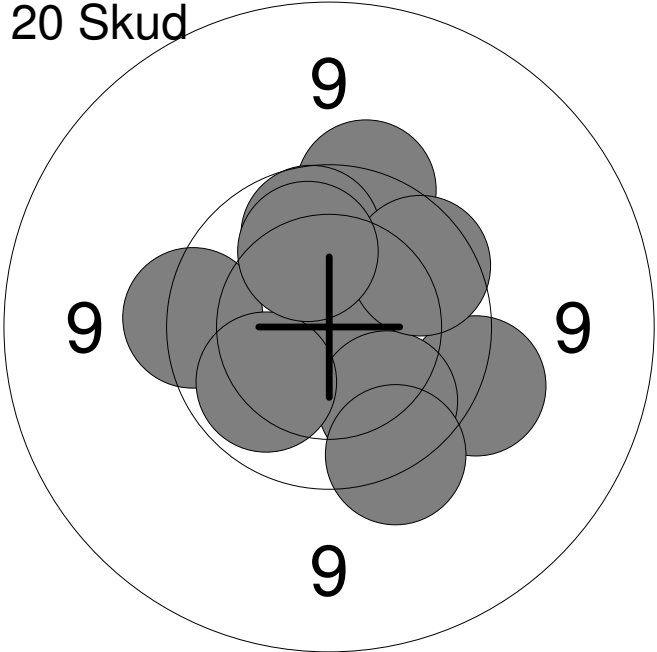
Hold	Skive	Kirsten Weinreich	
2	5	15m	Ulsted Skf. V2
28.02.2014	Nordjysk Mesterskab 2014, senio	Aalborg Skyttekreds	
Prøve 	1:	10.1	←
	2:	10.3	↗
	3:	9.9	↗
	4:	10.0	→
	5:	10.7x	↘
	Serie	49.0	
	Total	0.0	
20 Skud 	1:	10.6x	↘
	2:	10.8x	↘
	3:	10.0	↘
	4:	10.0	↘
	5:	10.3	↑
	6:	10.5	↗
	7:	10.4	↑
	8:	10.1	↗
	9:	10.3	→
	10:	10.2	↘
	Serie	100.0	
	Total	100.0	
20 Skud 	11:	9.6	↑
	12:	9.5	→
	13:	10.6x	↗
	14:	9.9	↘
	15:	9.9	↑
	16:	9.8	↗
	17:	9.7	←
	18:	10.0	↘
	19:	9.6	↘
	20:	10.1	↑
	Serie	93.0	
	Total	193.0	

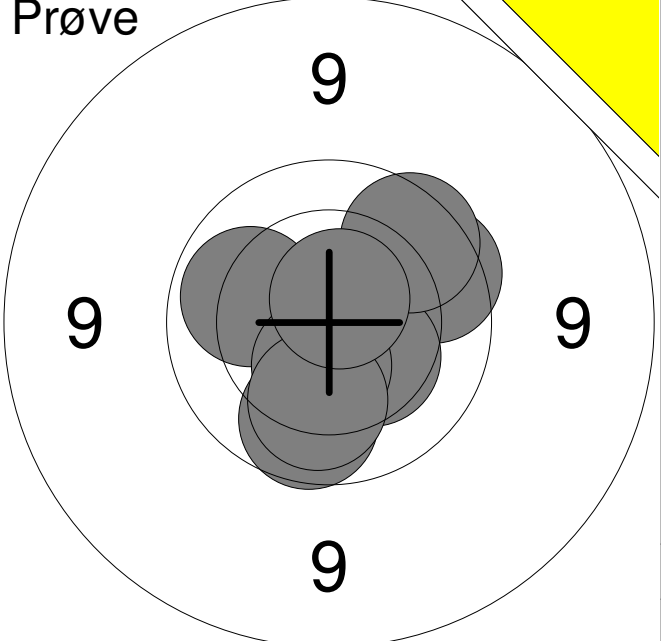
<p>Prøve</p> 	<table style="width:100%; border-collapse: collapse;"> <tr><td style="width:10%;">1:</td><td style="width:30%;">10.1</td><td style="width:10%; text-align:center;">←</td></tr> <tr><td>2:</td><td>9.8</td><td style="text-align:center;">→</td></tr> <tr><td>3:</td><td>10.4</td><td style="text-align:center;">↘</td></tr> <tr><td>4:</td><td>10.5</td><td style="text-align:center;">↓</td></tr> <tr><td>5:</td><td>9.9</td><td style="text-align:center;">↓</td></tr> <tr><td>6:</td><td>10.1</td><td style="text-align:center;">↓</td></tr> <tr><td>7:</td><td>9.8</td><td style="text-align:center;">↗</td></tr> <tr><td>8:</td><td>10.7x</td><td style="text-align:center;">↑</td></tr> </table>	1:	10.1	←	2:	9.8	→	3:	10.4	↘	4:	10.5	↓	5:	9.9	↓	6:	10.1	↓	7:	9.8	↗	8:	10.7x	↑
1:	10.1	←																							
2:	9.8	→																							
3:	10.4	↘																							
4:	10.5	↓																							
5:	9.9	↓																							
6:	10.1	↓																							
7:	9.8	↗																							
8:	10.7x	↑																							
<table style="width:100%; border-collapse: collapse;"> <tr> <td style="width:10%;">Serie</td> <td style="width:30%;"></td> <td style="width:10%; text-align:right;">77.0</td> </tr> <tr> <td>Total</td> <td></td> <td style="text-align:right;">0.0</td> </tr> </table>		Serie		77.0	Total		0.0																		
Serie		77.0																							
Total		0.0																							

<p>20 Skud</p> 	<table style="width:100%; border-collapse: collapse;"> <tr><td style="width:10%;">1:</td><td style="width:30%;">10.1</td><td style="width:10%; text-align:center;">↗</td></tr> <tr><td>2:</td><td>10.6x</td><td style="text-align:center;">←</td></tr> <tr><td>3:</td><td>10.3</td><td style="text-align:center;">↓</td></tr> <tr><td>4:</td><td>10.4</td><td style="text-align:center;">↑</td></tr> <tr><td>5:</td><td>10.4</td><td style="text-align:center;">→</td></tr> <tr><td>6:</td><td>9.8</td><td style="text-align:center;">↓</td></tr> <tr><td>7:</td><td>9.9</td><td style="text-align:center;">↓</td></tr> <tr><td>8:</td><td>10.3</td><td style="text-align:center;">→</td></tr> <tr><td>9:</td><td>10.7x</td><td style="text-align:center;">←</td></tr> <tr><td>10:</td><td>10.1</td><td style="text-align:center;">↗</td></tr> </table>	1:	10.1	↗	2:	10.6x	←	3:	10.3	↓	4:	10.4	↑	5:	10.4	→	6:	9.8	↓	7:	9.9	↓	8:	10.3	→	9:	10.7x	←	10:	10.1	↗
1:	10.1	↗																													
2:	10.6x	←																													
3:	10.3	↓																													
4:	10.4	↑																													
5:	10.4	→																													
6:	9.8	↓																													
7:	9.9	↓																													
8:	10.3	→																													
9:	10.7x	←																													
10:	10.1	↗																													
<table style="width:100%; border-collapse: collapse;"> <tr> <td style="width:10%;">Serie</td> <td style="width:30%;"></td> <td style="width:10%; text-align:right;">98.0</td> </tr> <tr> <td>Total</td> <td></td> <td style="text-align:right;">98.0</td> </tr> </table>		Serie		98.0	Total		98.0																								
Serie		98.0																													
Total		98.0																													

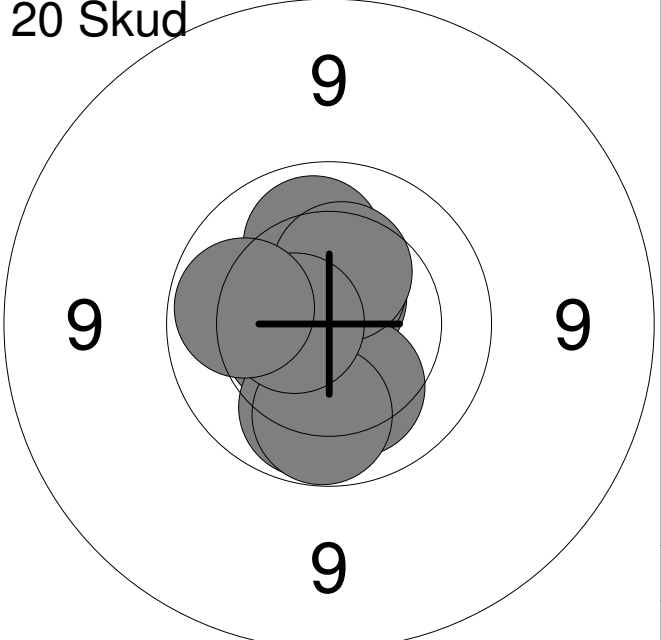
<p>20 Skud</p> 	<table style="width:100%; border-collapse: collapse;"> <tr><td style="width:10%;">11:</td><td style="width:30%;">10.1</td><td style="width:10%; text-align:center;">↑</td></tr> <tr><td>12:</td><td>10.7x</td><td style="text-align:center;">↑</td></tr> <tr><td>13:</td><td>10.5x</td><td style="text-align:center;">←</td></tr> <tr><td>14:</td><td>10.5x</td><td style="text-align:center;">↑</td></tr> <tr><td>15:</td><td>10.0</td><td style="text-align:center;">↓</td></tr> <tr><td>16:</td><td>10.2</td><td style="text-align:center;">↓</td></tr> <tr><td>17:</td><td>10.0</td><td style="text-align:center;">↓</td></tr> <tr><td>18:</td><td>10.4</td><td style="text-align:center;">↑</td></tr> <tr><td>19:</td><td>10.6x</td><td style="text-align:center;">←</td></tr> <tr><td>20:</td><td>10.0</td><td style="text-align:center;">←</td></tr> </table>	11:	10.1	↑	12:	10.7x	↑	13:	10.5x	←	14:	10.5x	↑	15:	10.0	↓	16:	10.2	↓	17:	10.0	↓	18:	10.4	↑	19:	10.6x	←	20:	10.0	←
11:	10.1	↑																													
12:	10.7x	↑																													
13:	10.5x	←																													
14:	10.5x	↑																													
15:	10.0	↓																													
16:	10.2	↓																													
17:	10.0	↓																													
18:	10.4	↑																													
19:	10.6x	←																													
20:	10.0	←																													
<table style="width:100%; border-collapse: collapse;"> <tr> <td style="width:10%;">Serie</td> <td style="width:30%;"></td> <td style="width:10%; text-align:right;">100.0</td> </tr> <tr> <td>Total</td> <td></td> <td style="text-align:right;">198.0</td> </tr> </table>		Serie		100.0	Total		198.0																								
Serie		100.0																													
Total		198.0																													

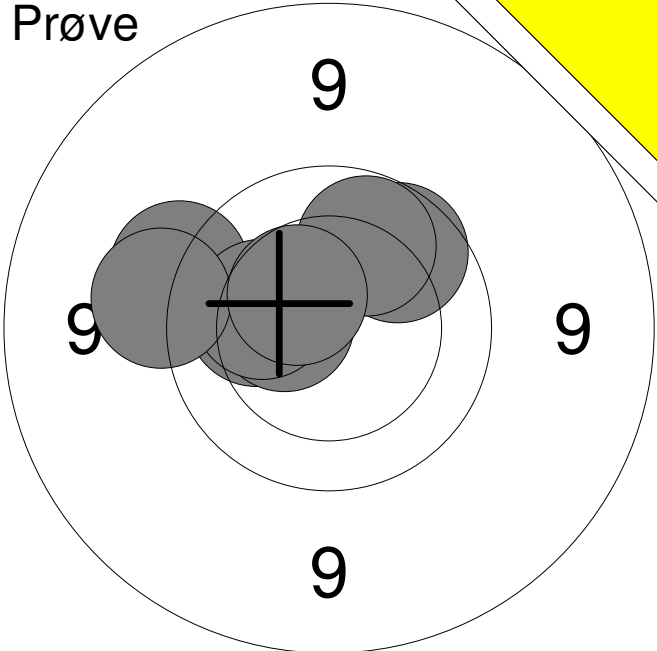
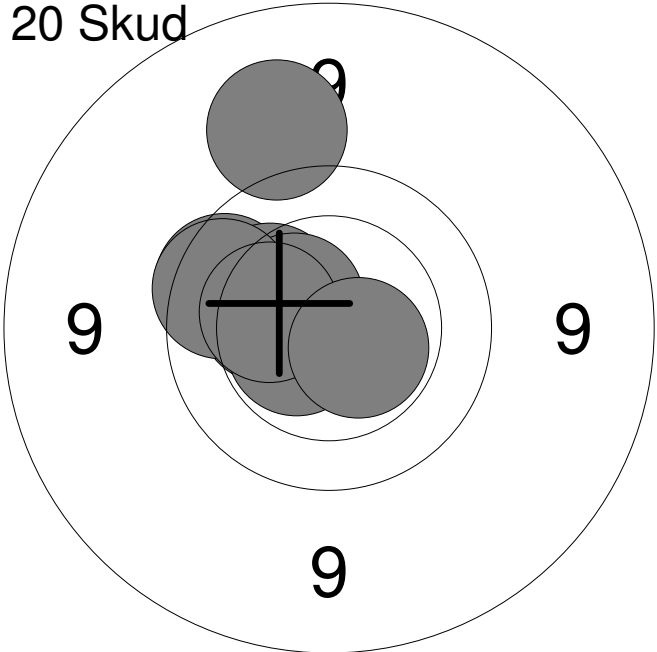
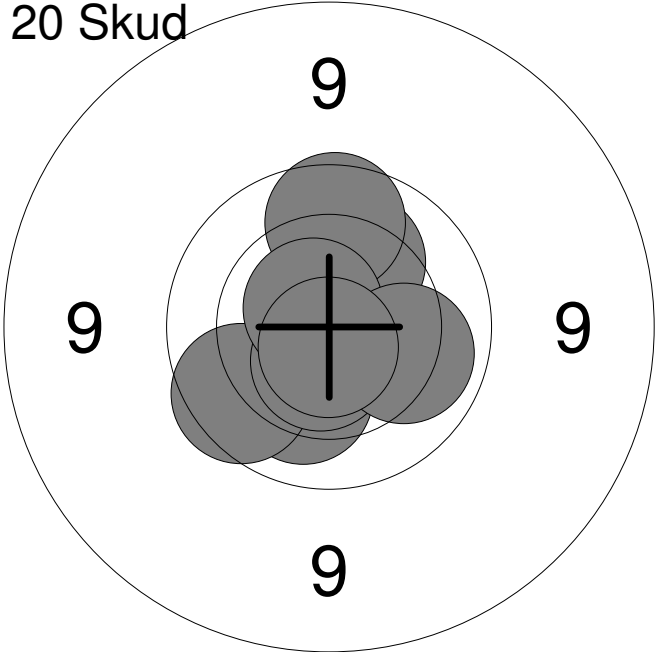
Hold	Skive	Ole Stefansen	
2	7	15m	Skf. Kimbrene V1
28.02.2014	Nordjysk Mesterskab 2014, senio	Aalborg Skyttekreds	
Prøve		1: 9.9 ↗	
		2: 9.5 ↖	
		3: 10.2 ↖	
		4: 10.5 ↖	
		5: 10.0 ↗	
		6: 10.2 ↖	
		7: 9.5 ↖	
		8: 10.5 ↗	
		Serie	77.0
		Total	0.0
20 Skud		1: 10.3 ↖	
		2: 10.2 ↗	
		3: 9.3 ↗	
		4: 9.8 ↗	
		5: 10.6x ↖	
		6: 10.2 ↗	
		7: 10.5 ↗	
		8: 9.8 ↗	
		9: 10.3 ↖	
		10: 10.6x ↘	
		Serie	97.0
		Total	97.0
20 Skud		11: 10.2 ↘	
		12: 9.8 ↖	
		13: 10.9x ↖	
		14: 10.8x ↗	
		15: 10.2 ↗	
		16: 9.9 ↗	
		17: 10.6x ↘	
		18: 10.7x ↗	
		19: 10.1 ↘	
		20: 10.7x ↘	
		Serie	98.0
		Total	195.0

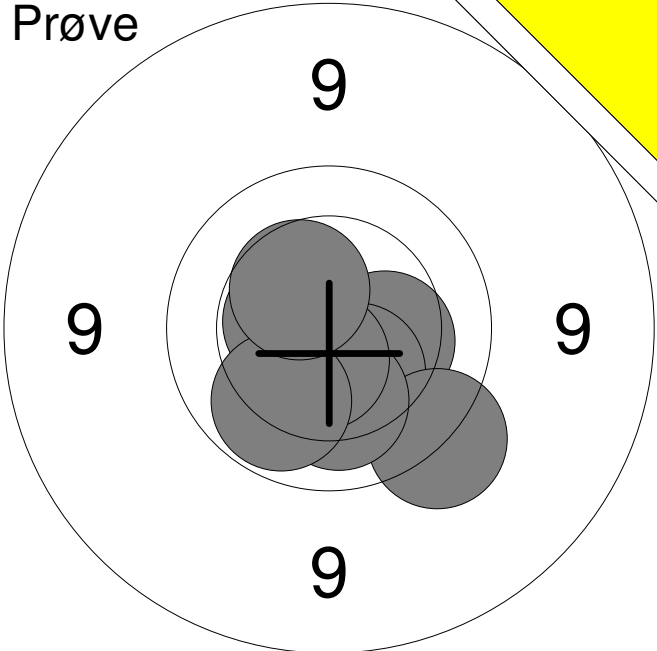
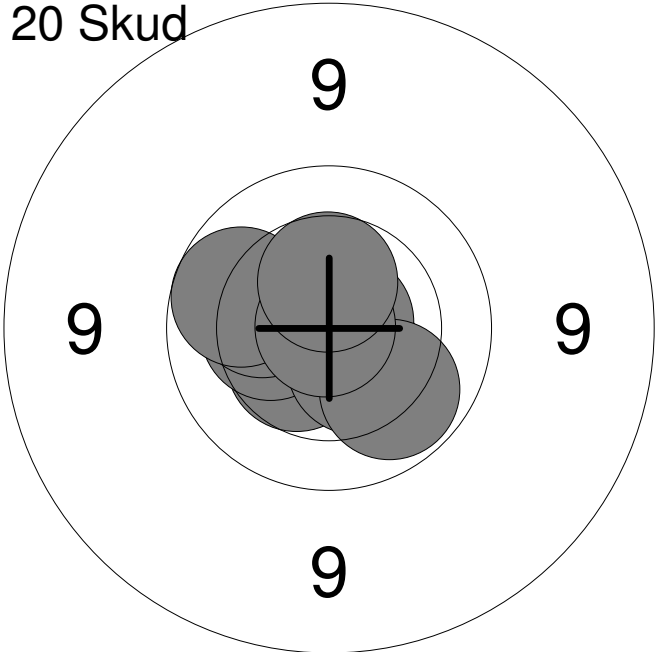
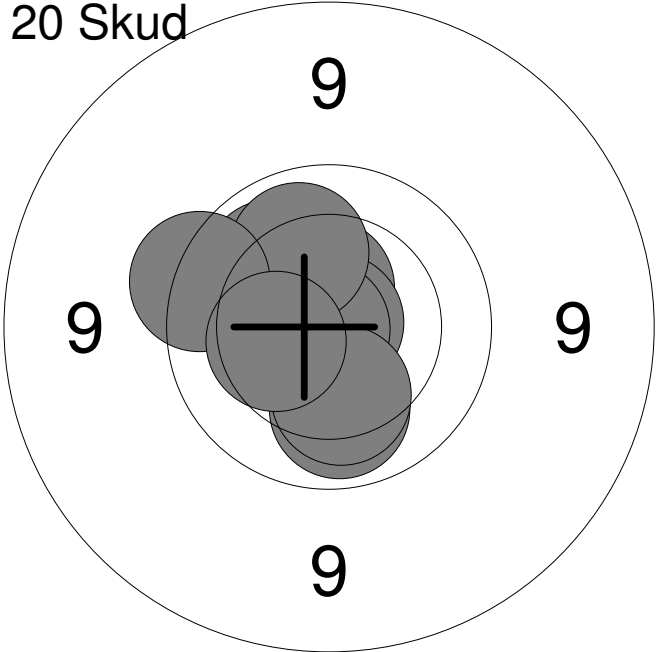
Hold	Skive	Brian Rubæk	
2	9	15m	Skf. Kimbrenne
28.02.2014	Nordjysk Mesterskab 2014, senio	Aalborg Skyttekreds	ÅK1
Prøve		1: 10.3 →	
		2: 10.4 ↓	
		3: 10.6x ↑	
		4: 9.6 ↓	
		5: 10.2 ↓	
		6: 10.6x ↓	
		7: 10.0 ↓	
		8: 10.4 ↗	
		Serie	79.0
		Total	0.0
20 Skud		1: 10.4 ↙	
		2: 10.3 ←	
		3: 10.5 ↓	
		4: 10.8x →	
		5: 10.7x ↗	
		6: 10.2 ↑	
		7: 9.9 ↑	
		8: 10.0 ↓	
		9: 10.9x ↑	
		10: 10.5 ↑	
		Serie	99.0
		Total	99.0
20 Skud		11: 10.5x ↑	
		12: 10.9x ↗	
		13: 10.7x ←	
		14: 10.1 ↗	
		15: 10.1 ↓	
		16: 10.9x ←	
		17: 10.1 ↗	
		18: 9.7 ↑	
		19: 10.2 ↓	
		20: 10.4 ←	
		Serie	99.0
		Total	198.0

Hold 2	Skive 10	Egon Larsen	
------------------	--------------------	--------------------	--

15m	Skf. Kimbrene	V1
-----	---------------	----

28.02.2014	Nordjysk Mesterskab 2014, senio	Aalborg Skyttekreds
------------	---------------------------------	---------------------

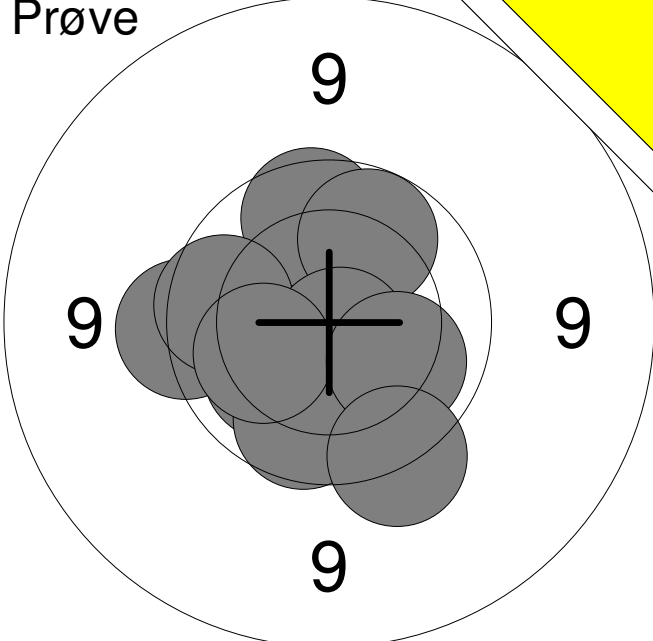
Prøve 	1:	10.2	↙
	2:	9.6	←
	3:	9.9	↑
	4:	9.9	←
	5:	10.0	↗
	6:	10.7x	↘
	7:	9.9	↘
	8:	10.2	←
	9:	10.1	↘
	10:	9.6	↘
	Serie		95.0
Total		0.0	

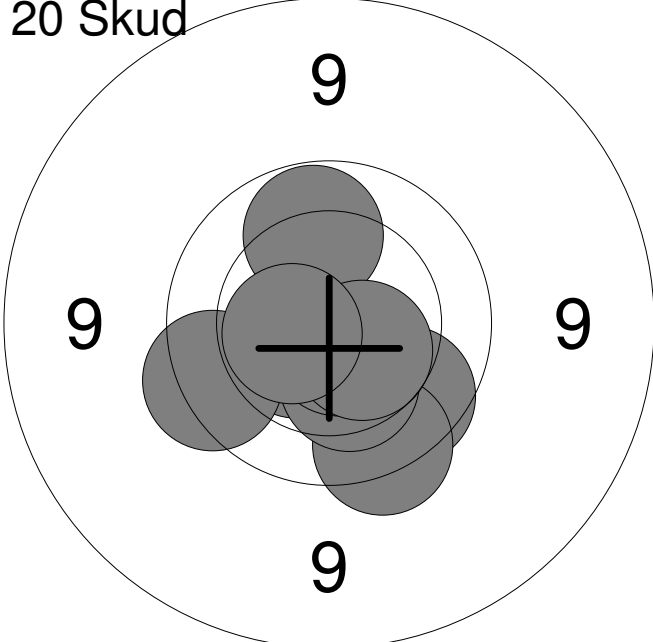
20 Skud 	1:	10.5x	↘
	2:	9.9	↘
	3:	9.7	↘
	4:	10.5x	←
	5:	10.3	↘
	6:	9.7	←
	7:	10.7x	↘
	8:	10.0	↑
	9:	10.5	↘
	10:	10.5x	←
	Serie		97.0
Total		97.0	

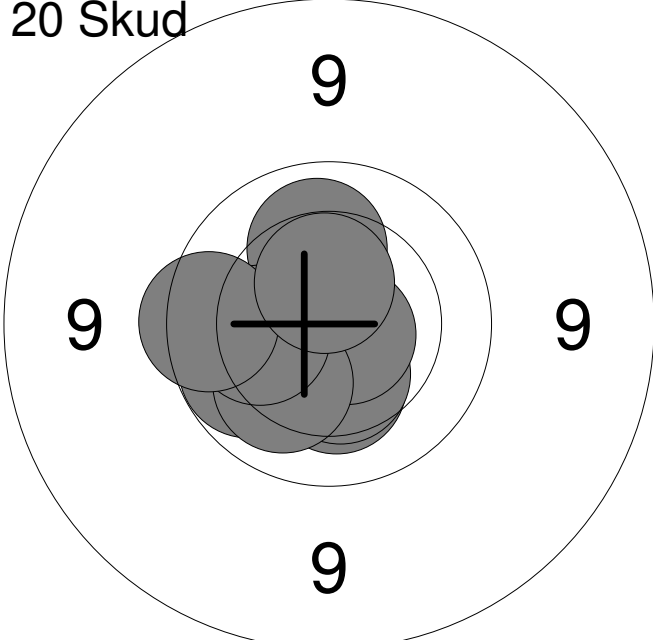
20 Skud 	11:	10.3	↘
	12:	10.0	←
	13:	10.5	←
	14:	10.4	↘
	15:	10.1	↑
	16:	10.7x	↘
	17:	10.1	↘
	18:	10.2	←
	19:	9.8	←
	20:	10.5x	↑
	Serie		99.0
Total		196.0	

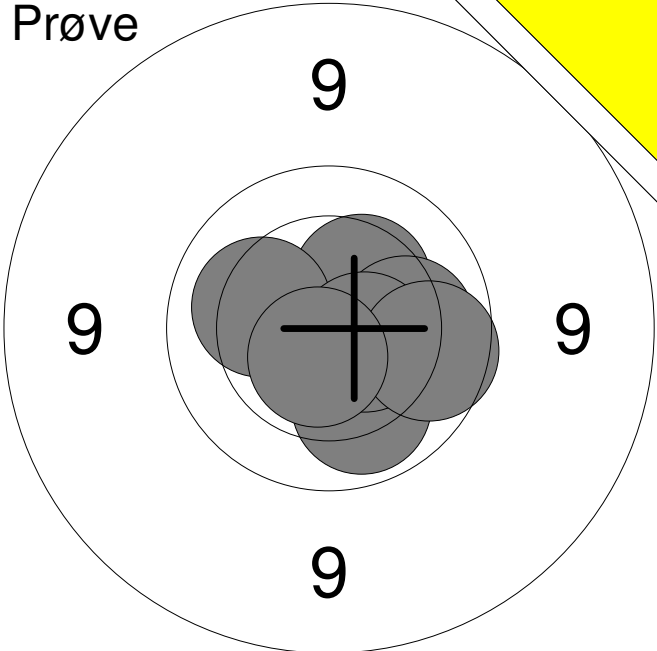
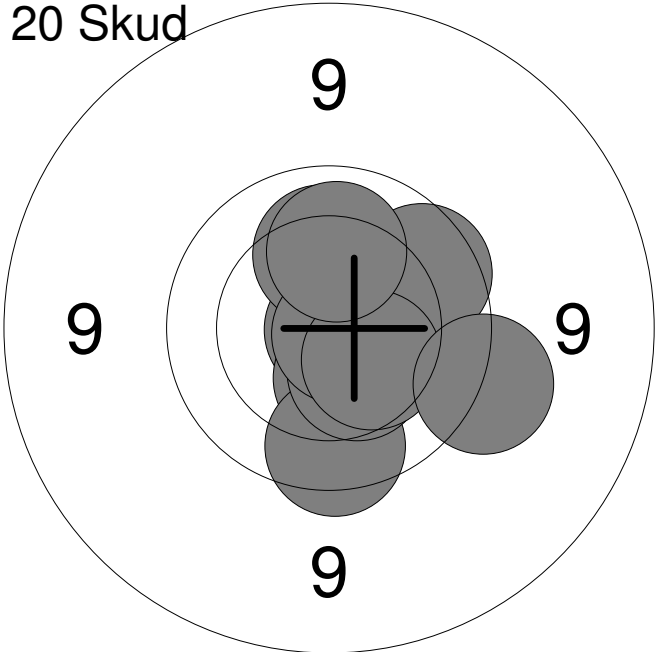
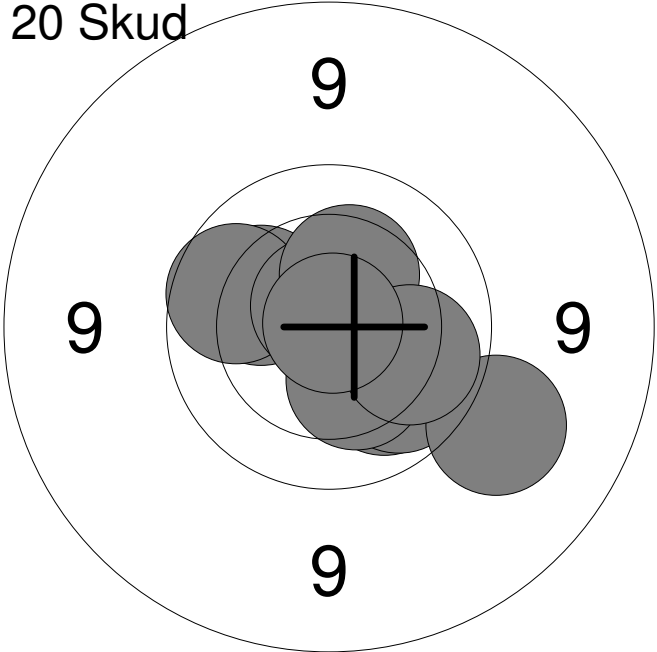
Hold	Skive	Morten Andersen	
2	11	15m	Skf. Kimbrene V1
28.02.2014	Nordjysk Mesterskab 2014, senio	Aalborg Skyttekreds	
Prøve		1: 10.8x ↗	
		2: 10.4 ↗	
		3: 10.2 ↖	
		4: 10.1 ↓	
		5: 10.1 →	
		6: 10.5x ↘	
		7: 9.9 →	
		8: 10.6x ↓	
		Serie 79.0	
		Total 0.0	
20 Skud		1: 10.9x →	
		2: 10.4 ↓	
		3: 9.8 ↓	
		4: 10.4 ↓	
		5: 10.2 ↑	
		6: 10.8x ↘	
		7: 9.9 →	
		8: 10.4 ↓	
		9: 9.5 →	
		10: 10.1 ↑	
		Serie 97.0	
		Total 97.0	
20 Skud		11: 10.1 ↓	
		12: 10.1 ↗	
		13: 10.0 ↓	
		14: 9.3 ↓	
		15: 9.9 ↗	
		16: 10.7x ↗	
		17: 10.3 ↗	
		18: 10.3 ↓	
		19: 10.0 ↘	
		20: 10.9x ↗	
		Serie 98.0	
		Total 195.0	

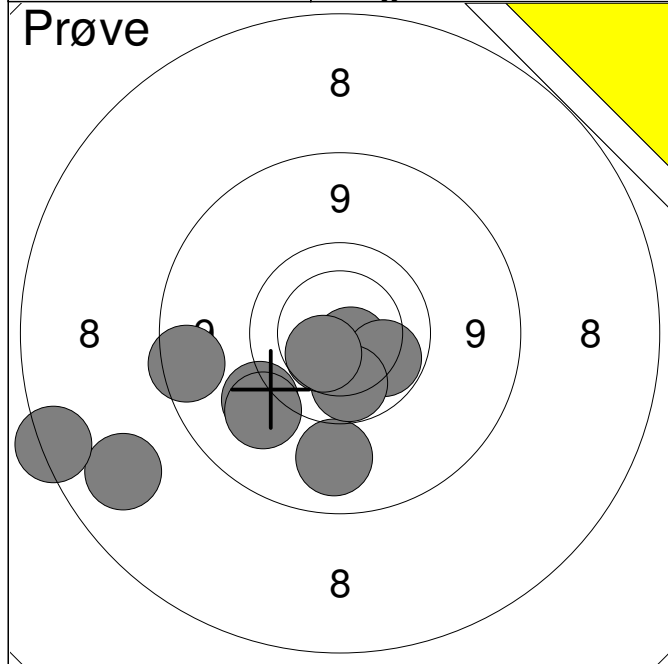

1:	8.1	↙
2:	10.6x	↘
3:	9.1	↓
4:	10.0	↘
5:	10.0	↓
6:	10.4	↙
7:	7.8	↙
8:	9.4	↙
9:	9.3	↙
10:	8.8	↙
Serie		90.0
Total		0.0

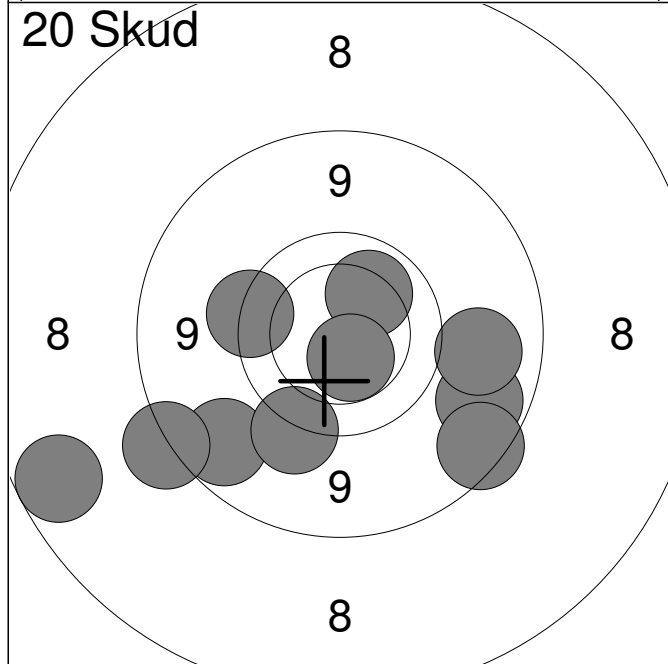

1:	9.0	↙
2:	10.1	↗
3:	8.0	↙
4:	9.6	↙
5:	9.0	↘
6:	9.1	→
7:	9.5	↙
8:	10.5x	↘
9:	8.8	↘
10:	8.7	↙
Serie		89.0
Total		89.0

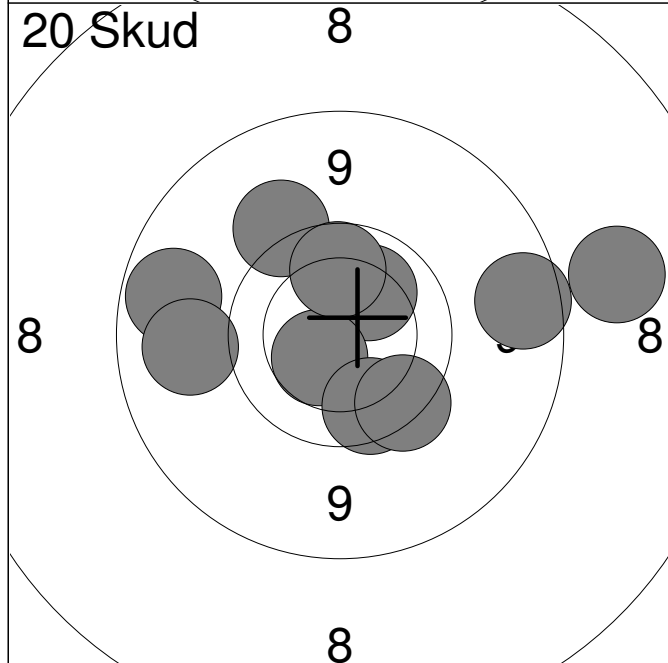

11:	10.1	↗
12:	9.0	↙
13:	9.2	↙
14:	9.4	↗
15:	10.5	↙
16:	8.3	→
17:	9.8	↓
18:	9.7	↘
19:	8.9	→
20:	9.9	↑
Serie		90.0
Total		179.0

<p>Prøve</p> 	<table style="width:100%; border-collapse: collapse;"> <tr><td style="width:10%;">1:</td><td style="width:70%;">10.0</td><td style="width:20%; text-align:right;">↗</td></tr> <tr><td>2:</td><td>9.5</td><td style="text-align:right;">→</td></tr> <tr><td>3:</td><td>9.5</td><td style="text-align:right;">↖</td></tr> <tr><td>4:</td><td>10.2</td><td style="text-align:right;">↑</td></tr> <tr><td>5:</td><td>10.2</td><td style="text-align:right;">↖</td></tr> <tr><td>6:</td><td>10.3</td><td style="text-align:right;">↑</td></tr> <tr><td>7:</td><td>9.6</td><td style="text-align:right;">↗</td></tr> <tr><td>8:</td><td>9.9</td><td style="text-align:right;">↑</td></tr> <tr><td>9:</td><td>10.1</td><td style="text-align:right;">↑</td></tr> <tr><td>10:</td><td>10.0</td><td style="text-align:right;">↑</td></tr> <tr><td colspan="2">Serie</td><td style="text-align:right;">96.0</td></tr> <tr><td colspan="2">Total</td><td style="text-align:right;">0.0</td></tr> </table>	1:	10.0	↗	2:	9.5	→	3:	9.5	↖	4:	10.2	↑	5:	10.2	↖	6:	10.3	↑	7:	9.6	↗	8:	9.9	↑	9:	10.1	↑	10:	10.0	↑	Serie		96.0	Total		0.0
1:	10.0	↗																																			
2:	9.5	→																																			
3:	9.5	↖																																			
4:	10.2	↑																																			
5:	10.2	↖																																			
6:	10.3	↑																																			
7:	9.6	↗																																			
8:	9.9	↑																																			
9:	10.1	↑																																			
10:	10.0	↑																																			
Serie		96.0																																			
Total		0.0																																			

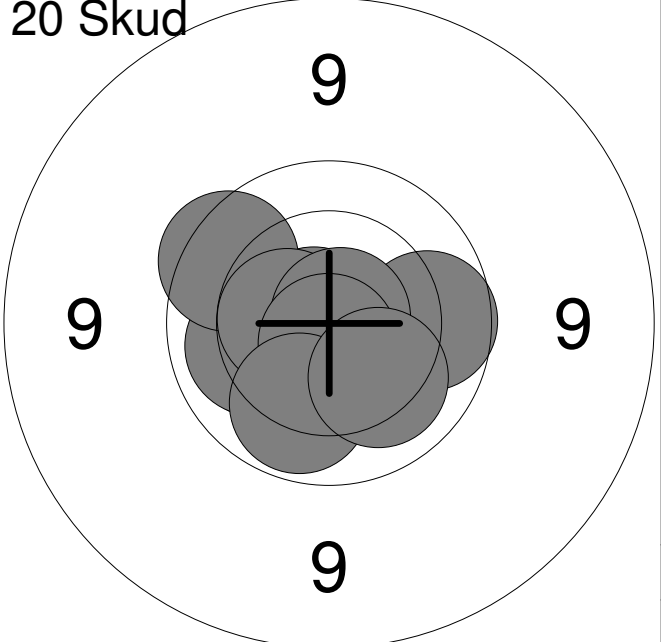
<p>20 Skud</p> 	<table style="width:100%; border-collapse: collapse;"> <tr><td style="width:10%;">1:</td><td style="width:70%;">10.8x</td><td style="width:20%; text-align:right;">↖</td></tr> <tr><td>2:</td><td>10.2</td><td style="text-align:right;">↖</td></tr> <tr><td>3:</td><td>10.1</td><td style="text-align:right;">↖</td></tr> <tr><td>4:</td><td>9.8</td><td style="text-align:right;">↖</td></tr> <tr><td>5:</td><td>10.5x</td><td style="text-align:right;">↖</td></tr> <tr><td>6:</td><td>9.9</td><td style="text-align:right;">→</td></tr> <tr><td>7:</td><td>10.8x</td><td style="text-align:right;">↗</td></tr> <tr><td>8:</td><td>10.7x</td><td style="text-align:right;">↓</td></tr> <tr><td>9:</td><td>10.0</td><td style="text-align:right;">↓</td></tr> <tr><td>10:</td><td>10.2</td><td style="text-align:right;">↓</td></tr> <tr><td colspan="2">Serie</td><td style="text-align:right;">98.0</td></tr> <tr><td colspan="2">Total</td><td style="text-align:right;">98.0</td></tr> </table>	1:	10.8x	↖	2:	10.2	↖	3:	10.1	↖	4:	9.8	↖	5:	10.5x	↖	6:	9.9	→	7:	10.8x	↗	8:	10.7x	↓	9:	10.0	↓	10:	10.2	↓	Serie		98.0	Total		98.0
1:	10.8x	↖																																			
2:	10.2	↖																																			
3:	10.1	↖																																			
4:	9.8	↖																																			
5:	10.5x	↖																																			
6:	9.9	→																																			
7:	10.8x	↗																																			
8:	10.7x	↓																																			
9:	10.0	↓																																			
10:	10.2	↓																																			
Serie		98.0																																			
Total		98.0																																			

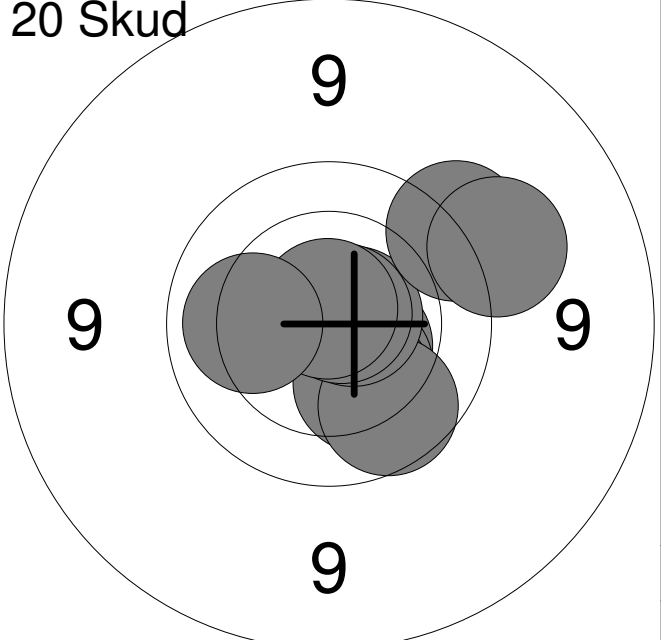
<p>20 Skud</p> 	<table style="width:100%; border-collapse: collapse;"> <tr><td style="width:10%;">11:</td><td style="width:70%;">10.5x</td><td style="width:20%; text-align:right;">↘</td></tr> <tr><td>12:</td><td>10.4</td><td style="text-align:right;">↘</td></tr> <tr><td>13:</td><td>10.2</td><td style="text-align:right;">↘</td></tr> <tr><td>14:</td><td>9.9</td><td style="text-align:right;">↘</td></tr> <tr><td>15:</td><td>10.7x</td><td style="text-align:right;">↗</td></tr> <tr><td>16:</td><td>9.6</td><td style="text-align:right;">↗</td></tr> <tr><td>17:</td><td>10.8x</td><td style="text-align:right;">↗</td></tr> <tr><td>18:</td><td>10.8x</td><td style="text-align:right;">↑</td></tr> <tr><td>19:</td><td>9.4</td><td style="text-align:right;">↗</td></tr> <tr><td>20:</td><td>10.1</td><td style="text-align:right;">←</td></tr> <tr><td colspan="2">Serie</td><td style="text-align:right;">97.0</td></tr> <tr><td colspan="2">Total</td><td style="text-align:right;">195.0</td></tr> </table>	11:	10.5x	↘	12:	10.4	↘	13:	10.2	↘	14:	9.9	↘	15:	10.7x	↗	16:	9.6	↗	17:	10.8x	↗	18:	10.8x	↑	19:	9.4	↗	20:	10.1	←	Serie		97.0	Total		195.0
11:	10.5x	↘																																			
12:	10.4	↘																																			
13:	10.2	↘																																			
14:	9.9	↘																																			
15:	10.7x	↗																																			
16:	9.6	↗																																			
17:	10.8x	↗																																			
18:	10.8x	↑																																			
19:	9.4	↗																																			
20:	10.1	←																																			
Serie		97.0																																			
Total		195.0																																			

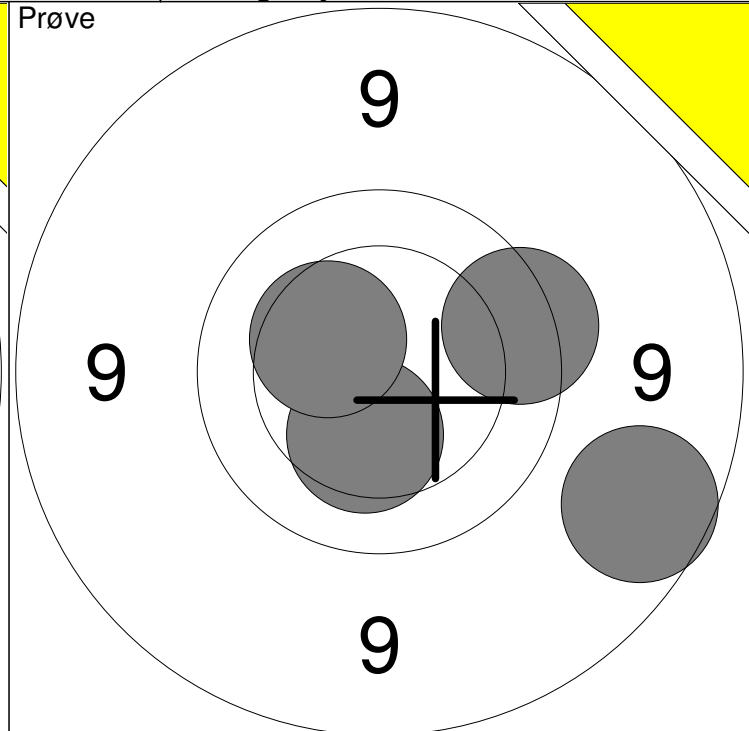
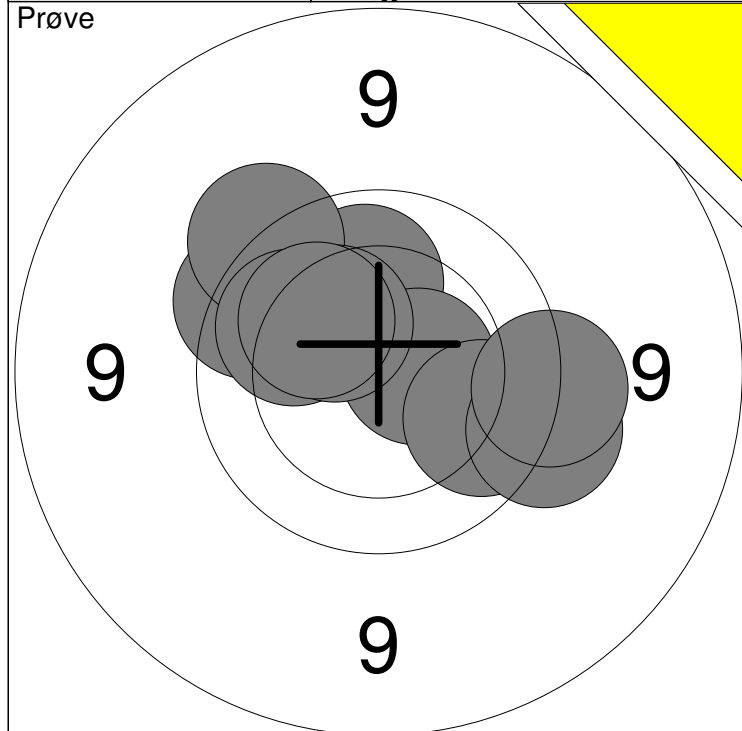

1: 9.7 ↗	6: 9.6 →	Serie	95
2: 10.1 ↑	7: 10.0 ↗		
3: 10.6x →	8: 9.6 →	Total	0
4: 9.6 ↗	9: 10.3 ↗		
5: 9.9 ↘	10: 10.2 ↗		

11: 8.9 →	Serie	37
12: 9.7 →		
13: 10.3 ↓	Total	0
14: 10.4 ↖		

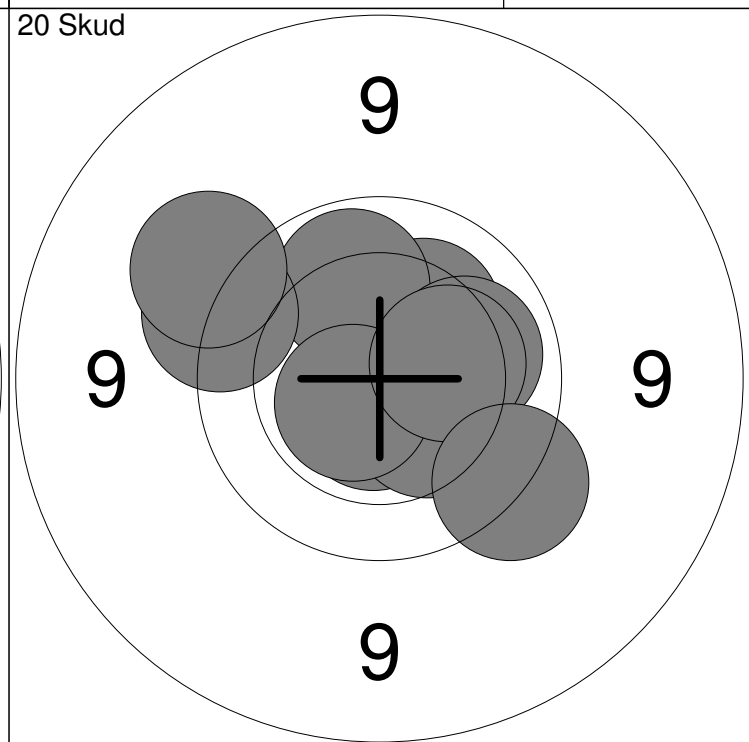
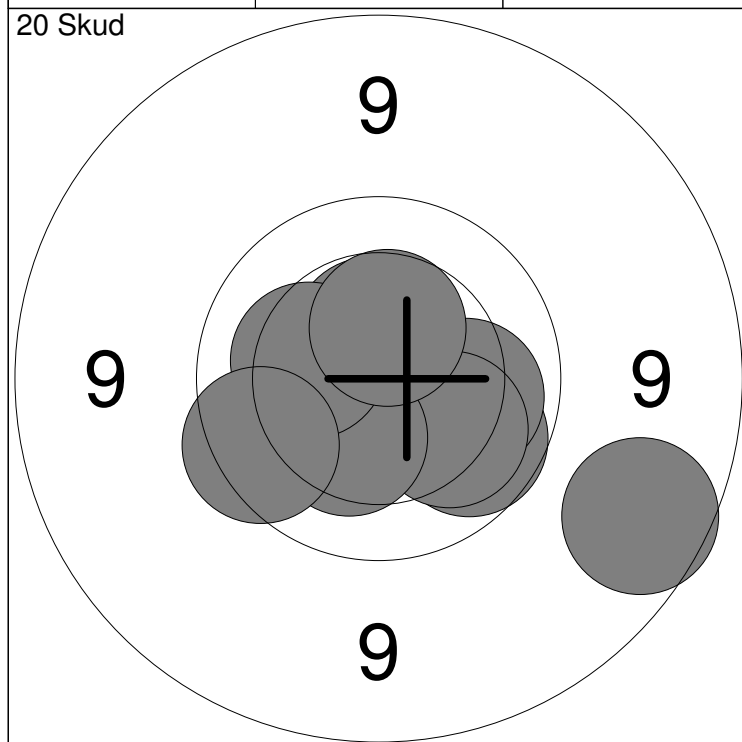

1: 9.9 ↘	6: 10.3 ↓	Serie	96
2: 10.8x ↑	7: 10.3 ←		
3: 10.5x ↑	8: 8.9 →	Total	96
4: 10.1 →	9: 10.5 ↑		
5: 10.1 ↘	10: 9.8 ←		

11: 10.2 ↗	16: 10.1 →	Serie	97
12: 10.0 ↑	17: 9.4 ↖		
13: 9.6 ←	18: 10.6x ↓	Total	193
14: 10.6x ↓	19: 10.3 →		
15: 10.3 ↘	20: 9.6 ↘		

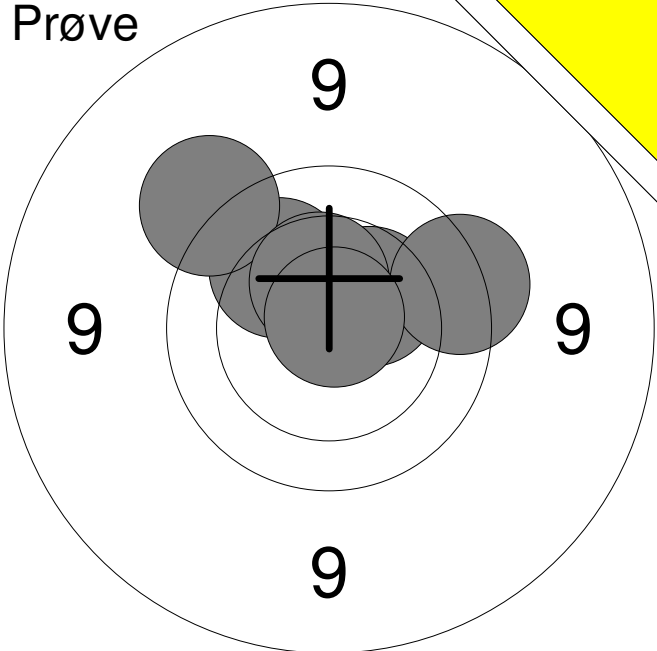
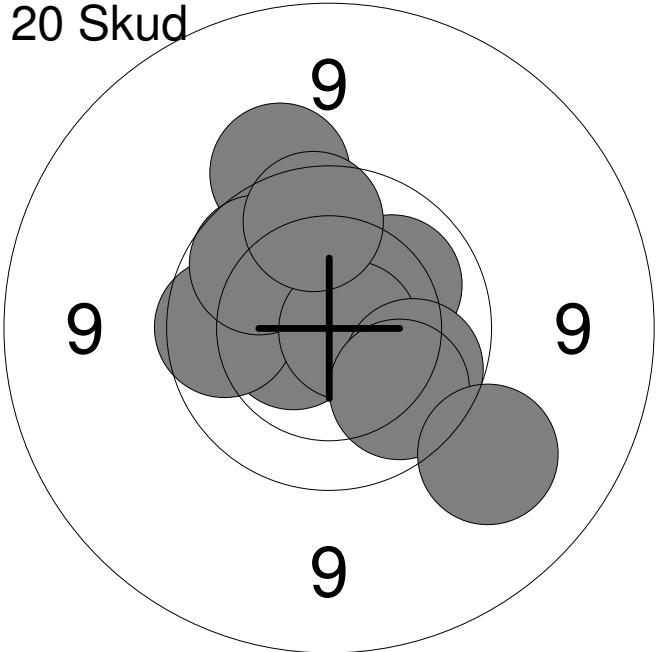
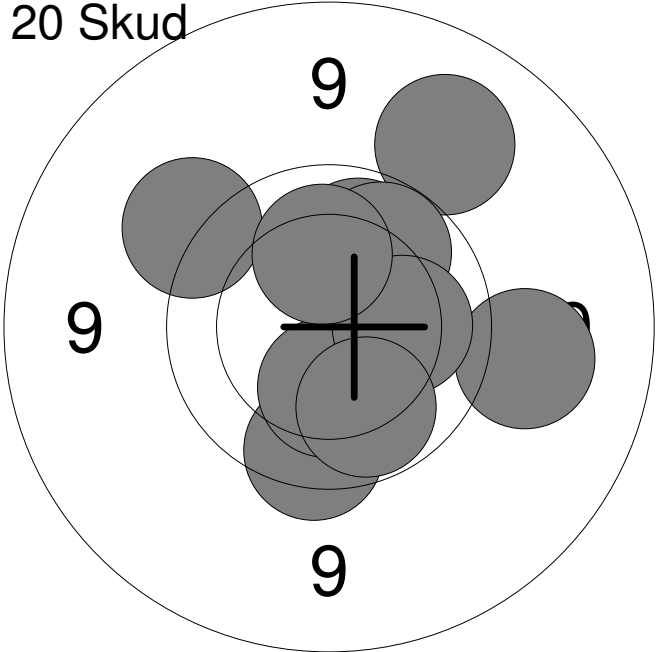
Hold	Skive	Egon Østergaard	
4	1	15m	Vester Han Herred Skytteforening2
28.02.2014	Nordjysk Mesterskab 2014, senio	Aalborg Skyttekreds	2
Prøve		1: 10.1	↗
		2: 10.4	↘
		3: 9.5	↗
		4: 9.7	↘
		5: 10.4	↗
		6: 10.8x	↗
		Serie	58.0
		Total	0.0
20 Skud		1: 9.5	↗
		2: 10.5x	↖
		3: 9.9	↖
		4: 9.9	↗
		5: 10.1	↘
		6: 10.7x	↘
		7: 9.9	↘
		8: 9.9	↘
		9: 9.3	↘
		10: 9.9	↗
		Serie	93.0
		Total	93.0
20 Skud		11: 9.8	↘
		12: 10.3	↘
		13: 9.2	↗
		14: 10.0	↗
		15: 10.0	↗
		16: 9.5	↗
		17: 9.3	↘
		18: 10.2	↘
		19: 10.0	↘
		20: 10.2	↗
		Serie	96.0
		Total	189.0

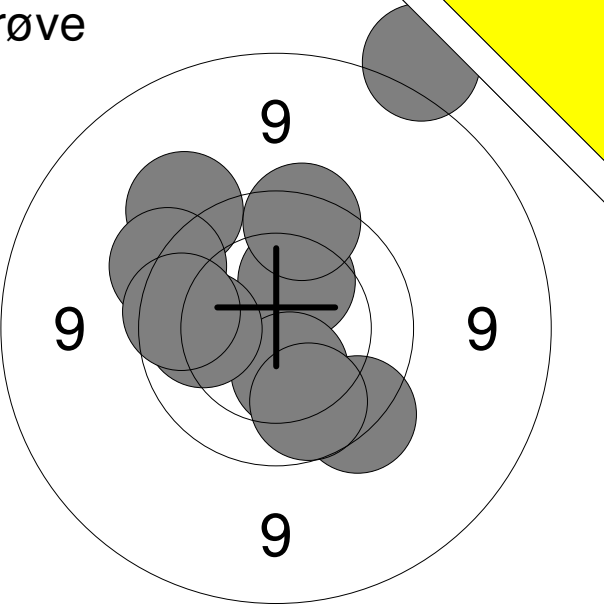
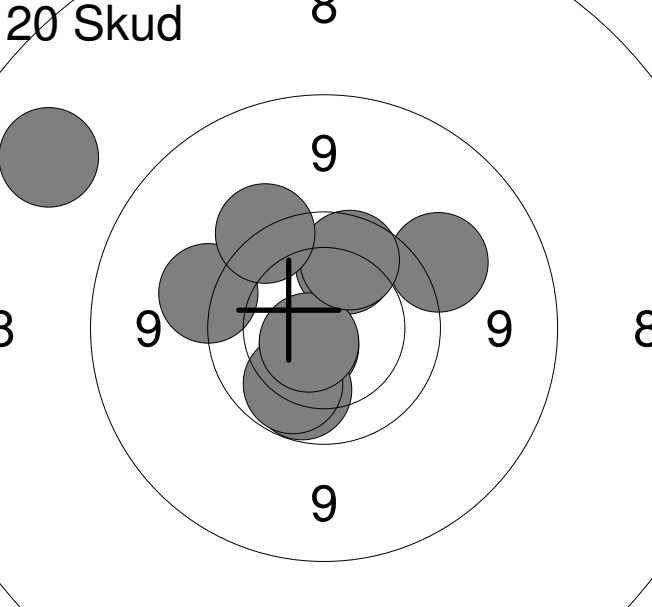
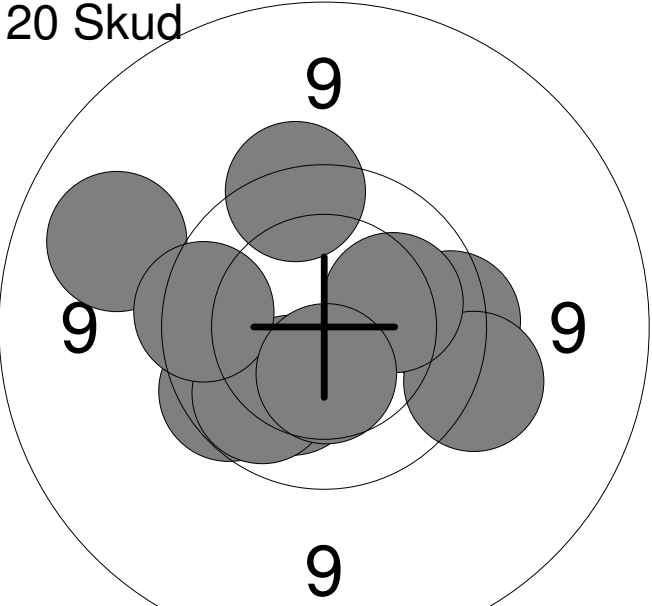
Hold	Skive	Louise Bedsted	
4	2		
15m	Vester Han Herred Skytteforening1	1	
28.02.2014	Nordjysk Mesterskab 2014, senio	Aalborg Skyttekreds	
Prøve 	1:	9.4	↗
	2:	9.7	↘
	3:	10.3	↗
	4:	9.6	↗
	5:	10.4	↘
	6:	10.0	←
	7:	8.5	↗
	8:	9.7	↗
	9:	9.8	←
	10:	9.9	↘
	Serie		92.0
Total		0.0	
20 Skud 	1:	10.6x	↙
	2:	10.0	↘
	3:	9.9	↗
	4:	8.2	↗
	5:	9.5	←
	6:	10.0	↘
	7:	9.4	↗
	8:	10.6x	↙
	9:	9.9	↗
	10:	9.6	↗
	Serie		93.0
Total		93.0	
20 Skud 	11:	10.2	↘
	12:	9.7	→
	13:	9.8	↙
	14:	9.1	↗
	15:	9.5	↘
	16:	10.0	↙
	17:	10.2	→
	18:	9.8	←
	19:	9.7	↗
	20:	10.4	↘
	Serie		94.0
Total		187.0	

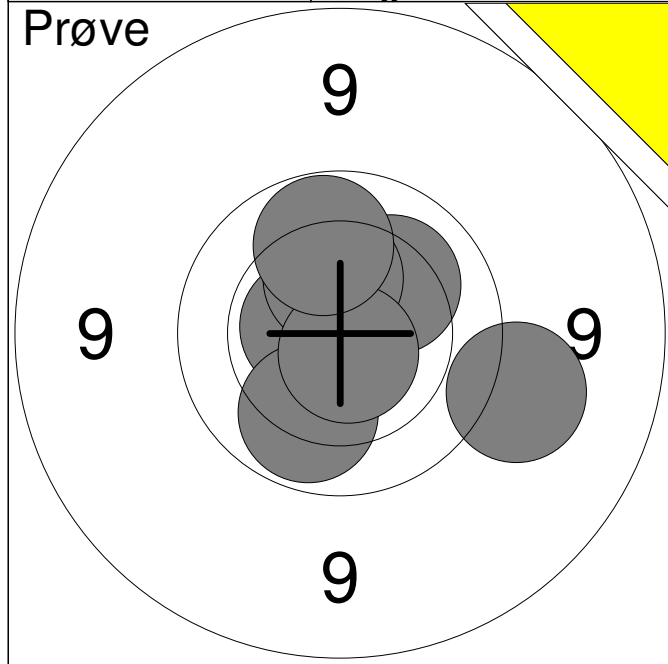

1:	9.4	→
2:	10.6x	←
3:	10.2	↗
4:	10.0	↓
5:	10.3	↑
6:	10.7x	↓
7:	10.0	↑
Serie		69.0
Total		0.0

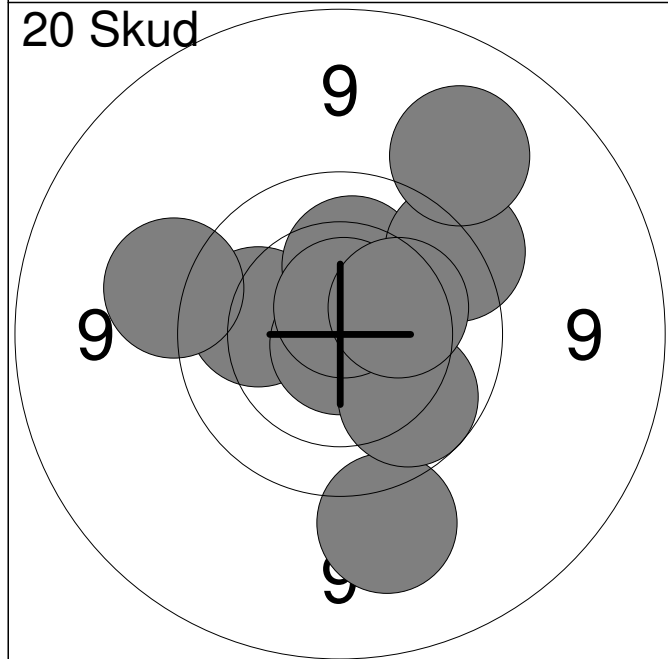

1:	10.0	←
2:	9.5	←
3:	10.2	↑
4:	9.3	↓
5:	9.7	↗
6:	10.8x	↓
7:	10.0	↓
8:	10.7x	↑
9:	9.2	↗
10:	10.3	↗
Serie		96.0
Total		96.0

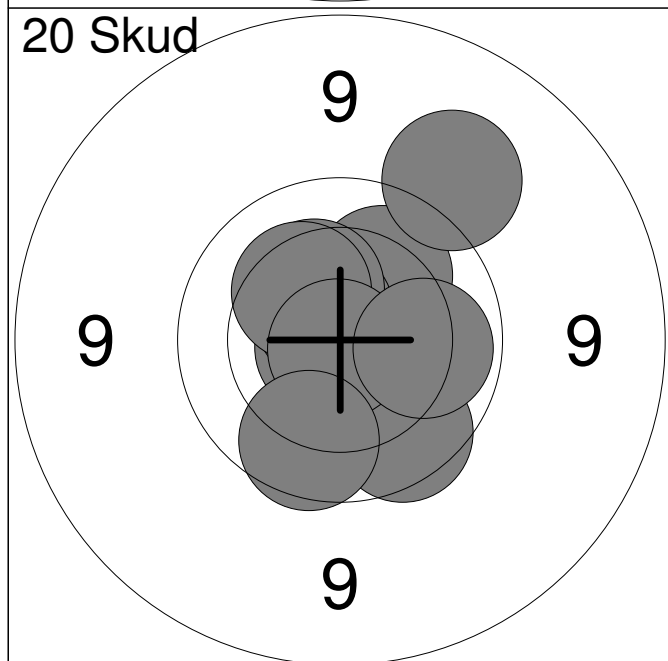

11:	10.8x	←
12:	10.1	↗
13:	9.8	↓
14:	9.3	↗
15:	10.6x	↗
16:	10.3	↗
17:	10.3	↗
18:	10.8x	↓
19:	9.9	↓
20:	10.0	→
Serie		97.0
Total		193.0

Hold 4	Skive 4	Svenne H. Weinreich	
------------------	-------------------	----------------------------	--

15m	Ulsted Skf.	MV2
-----	-------------	-----

28.02.2014	Nordjysk Mesterskab 2014, senio	Aalborg Skyttekreds
------------	---------------------------------	---------------------

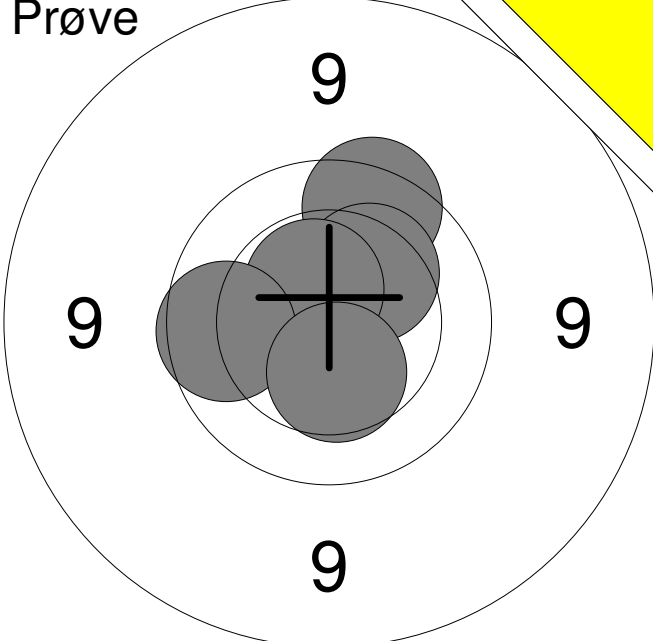
Prøve 	1: 9.8	↑
	2: 10.3	↗
	3: 10.6x	↑
	4: 9.9	←
	5: 10.4	↓
Serie		48.0
Total		0.0

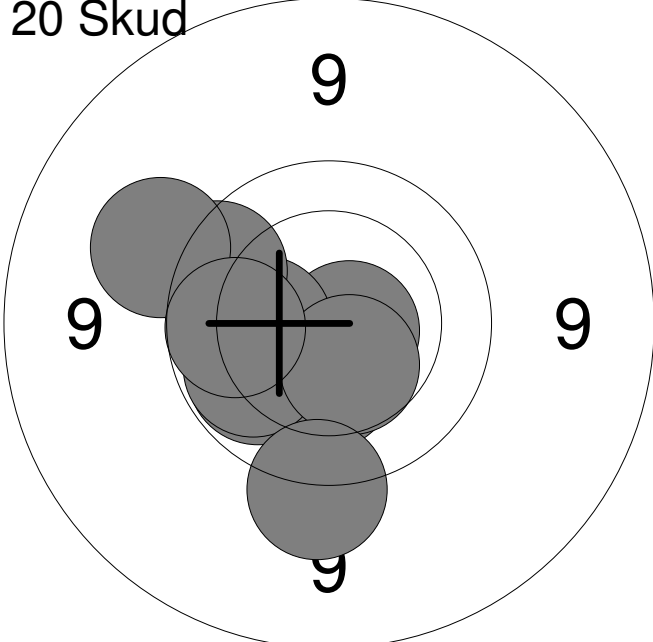
20 Skud 	1: 10.0	↙
	2: 10.7x	→
	3: 10.3	↓
	4: 10.2	←
	5: 10.0	↙
	6: 9.8	↗
	7: 9.4	↗
	8: 10.4	↓
	9: 9.9	←
	10: 9.5	↓
Serie		96.0
Total		96.0

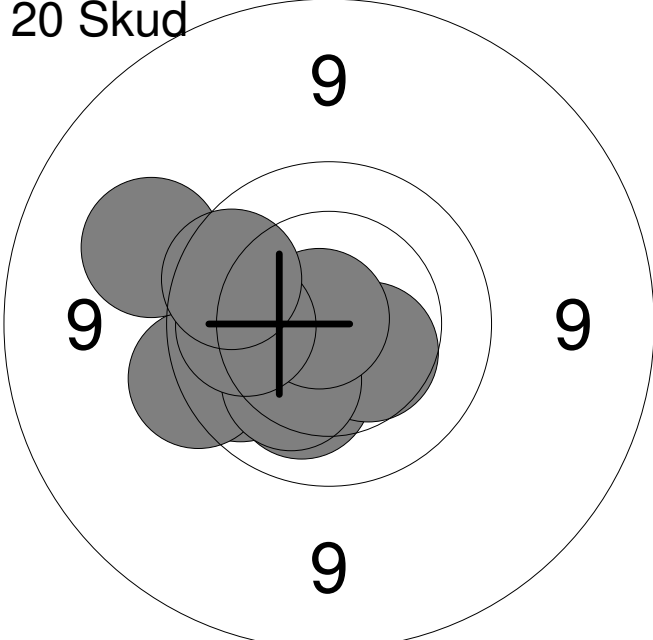
20 Skud 	11: 10.2	↓
	12: 9.9	↙
	13: 10.5x	←
	14: 9.6	↙
	15: 10.4	↘
	16: 9.3	↗
	17: 10.2	↙
	18: 10.8x	↗
	19: 10.1	←
	20: 9.9	↗
Serie		96.0
Total		192.0

Hold	Skive	Kirsten Weinreich	
4	5		
15m	Ulsted Skf.		MV2
28.02.2014	Nordjysk Mesterskab 2014, senio	Aalborg Skyttekreds	
Prøve		1: 9.8 ↗	
		2: 10.4 ↗	
		3: 10.3 ↘	
		4: 9.5 ↗	
		5: 10.0 ↖	
		Serie	48.0
		Total	0.0
20 Skud		1: 10.5x ↓	
		2: 10.6x →	
		3: 10.3 ↗	
		4: 10.0 ↗	
		5: 10.7x ↓	
		6: 10.3 ↖	
		7: 9.7 ↗	
		8: 10.3 ↗	
		9: 10.7x ↗	
		10: 9.4 →	
		Serie	98.0
		Total	98.0
20 Skud		11: 9.6 ↗	
		12: 8.9 ↗	
		13: 9.9 ↗	
		14: 10.5x ↓	
		15: 10.0 ↗	
		16: 9.7 ↗	
		17: 10.7x ↗	
		18: 10.2 →	
		19: 10.2 ↘	
		20: 10.0 →	
		Serie	95.0
		Total	193.0

Hold	Skive	Bente W. Kjølgaard	
4	6	15m	Skf. Kimbrene MV1
28.02.2014	Nordjysk Mesterskab 2014, senio	Aalborg Skyttekreds	
Prøve 	1:	9.0	↖
	2:	10.5x	↑
	3:	9.9	→
	4:	10.4	→
	5:	10.7x	→
	6:	9.9	↑
	Serie	57.0	
	Total	0.0	
20 Skud 	1:	10.8x	↑
	2:	10.3	↘
	3:	10.3	→
	4:	10.2	↖
	5:	10.6x	↙
	6:	10.3	↖
	7:	10.6x	→
	8:	10.0	→
	9:	10.1	↖
	10:	10.7x	↖
	Serie	100.0	
	Total	100.0	
20 Skud 	11:	9.5	↖
	12:	9.8	↑
	13:	10.2	↘
	14:	10.0	↖
	15:	10.5	↖
	16:	10.8x	↑
	17:	9.8	↖
	18:	10.7x	→
	19:	10.6x	↖
	20:	9.7	↑
	Serie	96.0	
	Total	196.0	

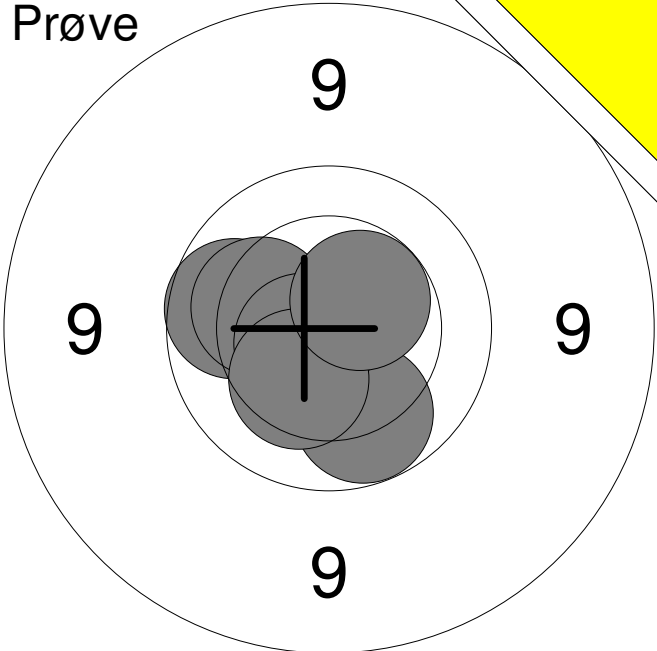
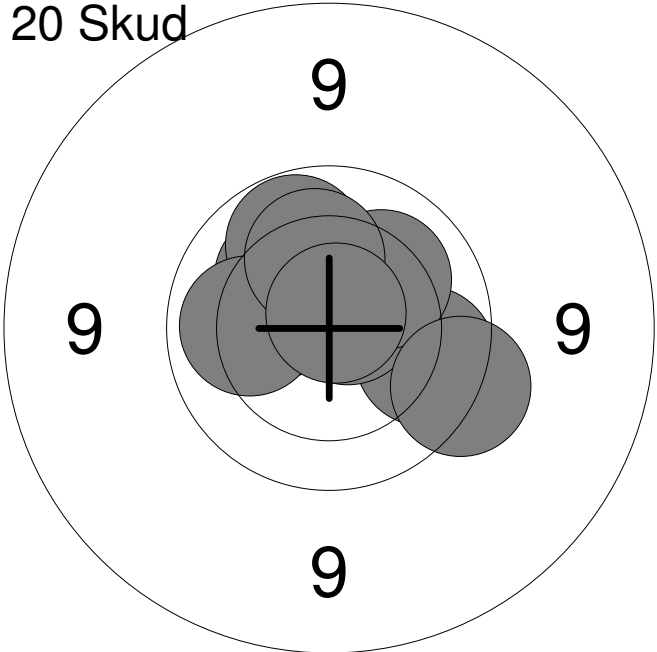
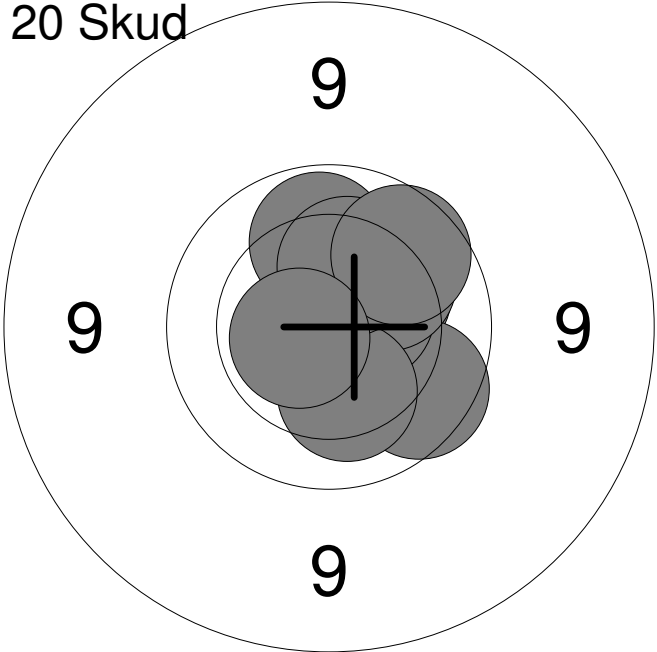
Hold 4	Skive 7	Ole Stefansen	
15m	Skf. Kimbrene	MV1	
28.02.2014	Nordjysk Mesterskab 2014, senio	Aalborg Skyttekreds	
Prøve 	1:	10.0	↓
	2:	9.9	←
	3:	10.2	←
	4:	10.6x	←
	5:	10.3	↓
	6:	10.5x	↗
	Serie	59.0	
	Total	0.0	
20 Skud 	1:	10.2	↗
	2:	9.9	→
	3:	10.4	↗
	4:	10.7x	↗
	5:	10.2	↗
	6:	10.0	↗
	7:	10.1	←
	8:	10.2	↑
	9:	9.6	→
	10:	10.8x	↗
	Serie	98.0	
	Total	98.0	
20 Skud 	11:	10.0	↑
	12:	10.3	↗
	13:	9.8	↘
	14:	10.5	↗
	15:	10.5x	↗
	16:	10.1	↗
	17:	10.2	↓
	18:	10.3	↑
	19:	9.9	↗
	20:	10.6x	←
	Serie	98.0	
	Total	196.0	

Hold 4	Skive 8	Henrik Frankfurth	
------------------	-------------------	--------------------------	--

15m	Aalborg Skyttekreds	1	
-----	---------------------	---	--

28.02.2014	Nordjysk Mesterskab 2014, senio	Aalborg Skyttekreds	
------------	---------------------------------	---------------------	--

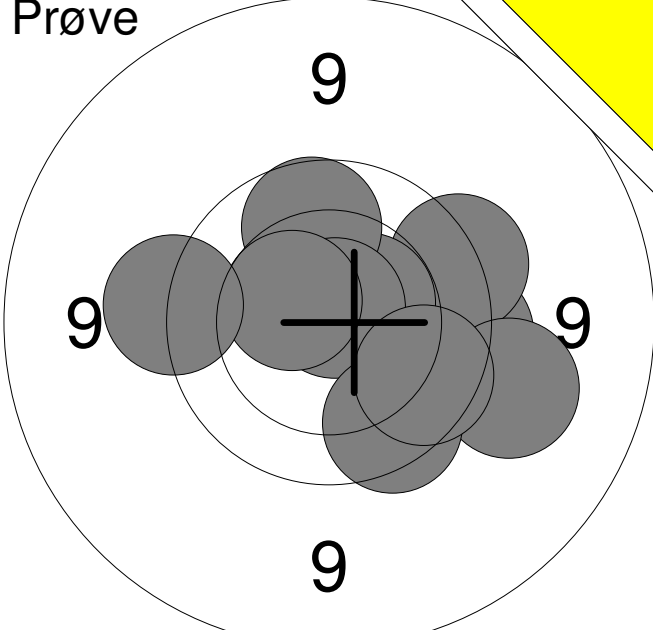
Prøve 	1:	9.7	→
	2:	9.6	→
	3:	10.5x	→
	4:	9.3	→
	5:	9.9	↑
	6:	10.8x	↑
	7:	10.5	↗
	8:	9.8	↓
	9:	9.6	↖
	10:	9.9	↓
	Serie		93.0
Total		0.0	

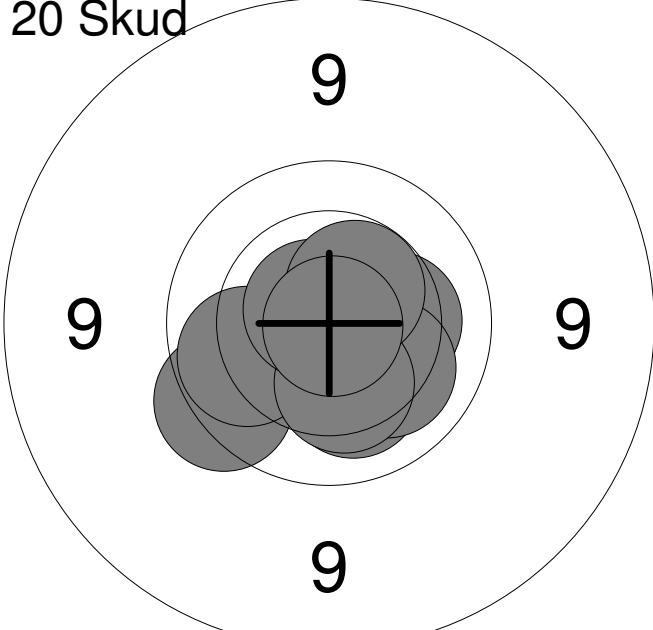
20 Skud 	1:	10.3	→
	2:	9.7	↙
	3:	10.3	→
	4:	10.0	↙
	5:	10.2	↓
	6:	10.2	↘
	7:	10.3	↓
	8:	10.7x	↗
	9:	10.5x	↗
	10:	10.9x	↓
	Serie		99.0
Total		99.0	

20 Skud 	11:	10.1	↘
	12:	10.8x	↙
	13:	9.9	↑
	14:	10.0	↘
	15:	10.2	↖
	16:	10.0	↘
	17:	10.0	↗
	18:	10.3	↗
	19:	10.8x	↘
	20:	10.2	↑
	Serie		99.0
Total		198.0	

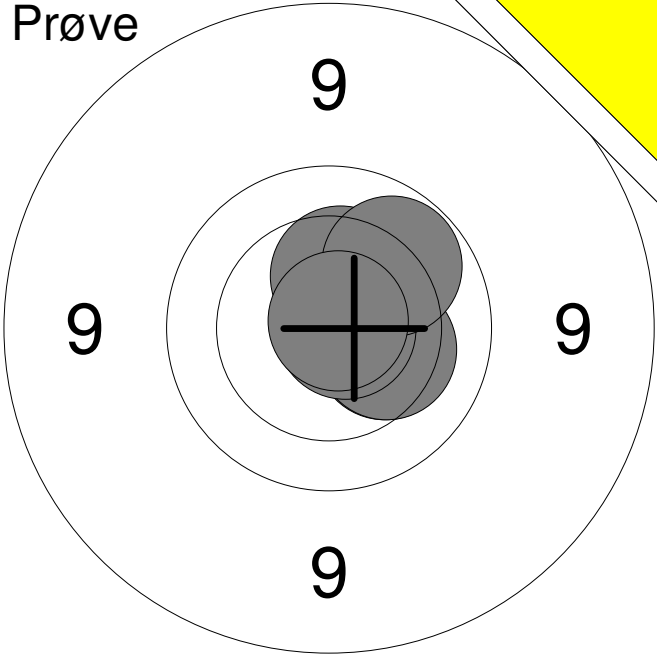
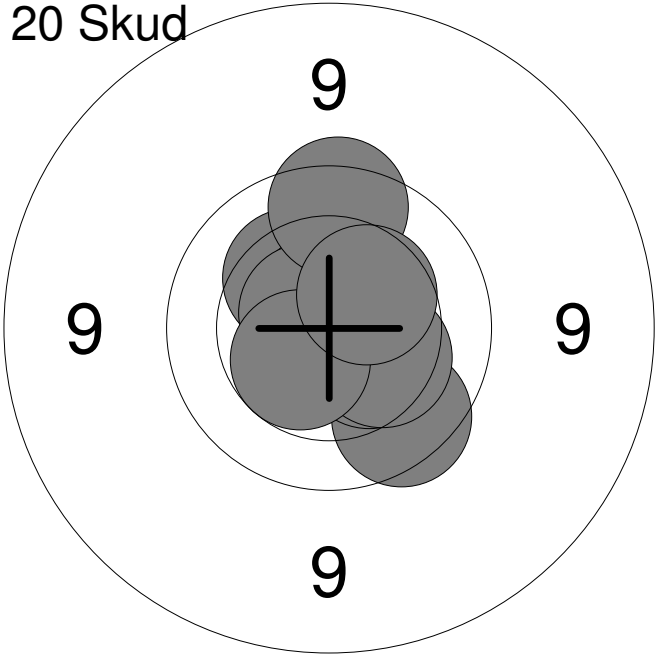
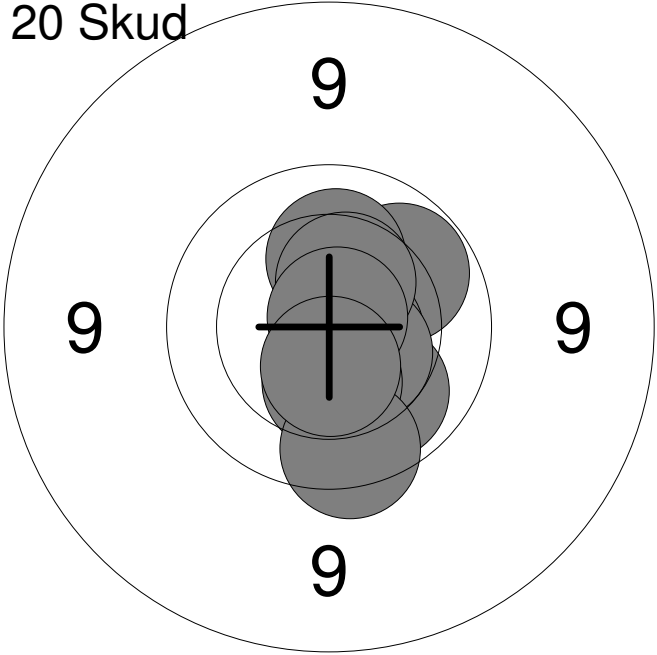
Hold	Skive	Brian Rubæk	
4	9	15m	Skf. Kimbrene
28.02.2014	Nordjysk Mesterskab 2014, senio	Aalborg Skyttekreds	MÅ1
Prøve		1: 10.3	→
		2: 10.4	↑
		3: 10.3	→
		4: 10.8x	→
		5: 10.0	↗
		6: 10.8x	↗
		Serie	60.0
		Total	0.0
20 Skud		1: 10.4	→
		2: 9.8	↓
		3: 10.3	↗
		4: 10.4	↓
		5: 10.7x	↑
		6: 10.7x	↗
		7: 9.8	↑
		8: 10.3	↓
		9: 10.5x	↙
		10: 10.4	↗
		Serie	98.0
		Total	98.0
20 Skud		11: 10.1	↘
		12: 10.0	↗
		13: 10.7x	→
		14: 10.2	↑
		15: 10.5x	↘
		16: 10.4	↗
		17: 10.3	↓
		18: 9.8	↓
		19: 10.8x	↗
		20: 10.5x	↓
		Serie	99.0
		Total	197.0

Hold 4	Skive 10	Egon Larsen	
------------------	--------------------	--------------------	--

15m	Skf. Kimbrenne	MV1
-----	----------------	-----

28.02.2014	Nordjysk Mesterskab 2014, senio	Aalborg Skyttekreds
------------	---------------------------------	---------------------

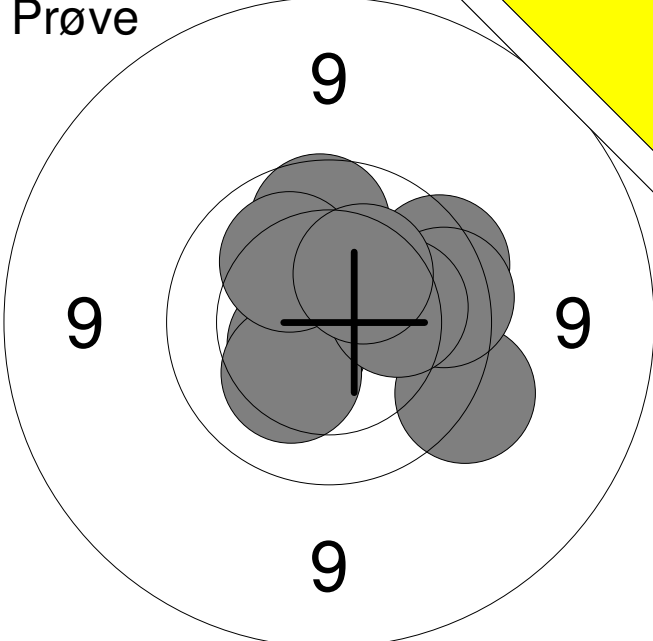
Prøve 	1:	9.6	→
	2:	10.5x	↙
	3:	9.8	→
	4:	10.5	↑
	5:	9.8	→
	6:	9.9	↑
	7:	10.3	↙
	8:	10.2	→
	9:	10.2	↑
	10:	10.3	↗
	Serie		96.0
Total		0.0	

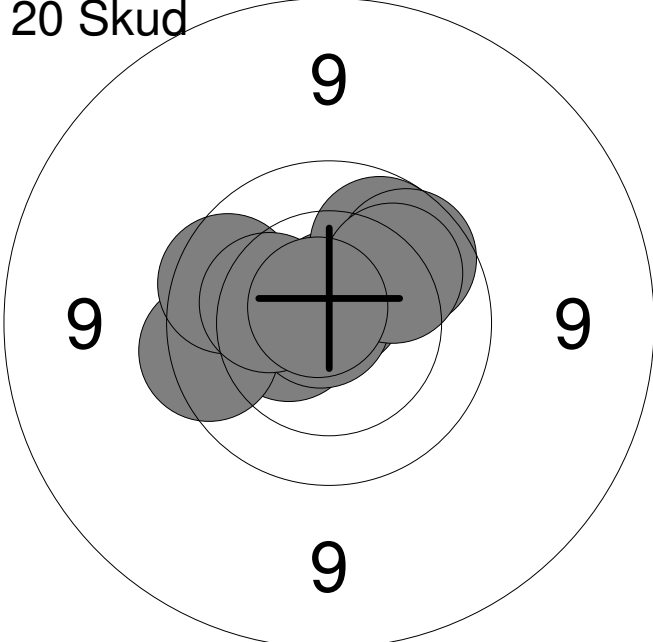
20 Skud 	1:	10.5x	←
	2:	9.8	←
	3:	10.7x	↑
	4:	9.9	↙
	5:	10.0	↗
	6:	10.8x	↙
	7:	9.9	↗
	8:	10.1	↗
	9:	10.3	←
	10:	10.7x	↗
	Serie		97.0
Total		97.0	

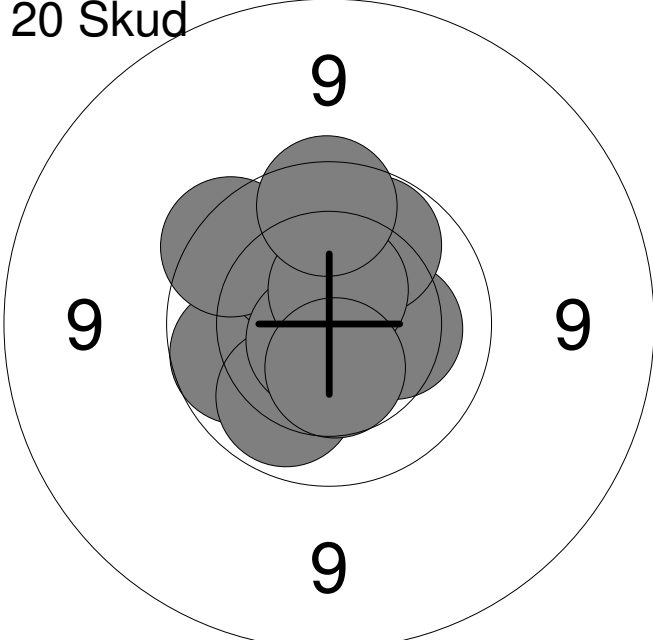
20 Skud 	11:	10.3	→
	12:	9.9	←
	13:	10.0	↙
	14:	10.0	↗
	15:	10.2	↗
	16:	9.7	↗
	17:	10.7x	↙
	18:	10.6x	↑
	19:	9.8	↑
	20:	10.5	↓
	Serie		97.0
Total		194.0	

Hold 4	Skive 11	Morten Andersen	
15m	Skf. Kimbrene	MV1	
28.02.2014	Nordjysk Mesterskab 2014, senio	Aalborg Skyttekreds	
Prøve		1: 10.6x	↑
		2: 10.6x	↓
		3: 9.8	→
		4: 9.9	→
		5: 10.1	↓
		6: 10.5	↓
		7: 10.4	↓
		Serie	68.0
		Total	0.0
20 Skud		1: 9.3	←
		2: 10.4	↗
		3: 10.4	→
		4: 9.9	↖
		5: 10.7x	←
		6: 10.0	→
		7: 10.5x	↗
		8: 10.1	↓
		9: 10.5x	→
		10: 10.0	↓
		Serie	98.0
		Total	98.0
20 Skud		11: 10.3	←
		12: 10.0	←
		13: 10.0	→
		14: 10.0	↓
		15: 10.0	→
		16: 10.7x	↗
		17: 10.4	↗
		18: 10.5	↑
		19: 10.1	↑
		20: 9.7	←
		Serie	99.0
		Total	197.0

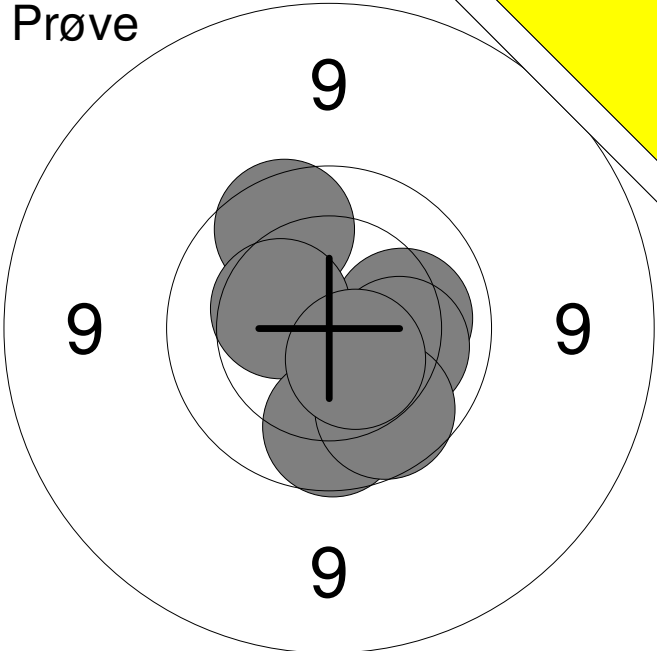
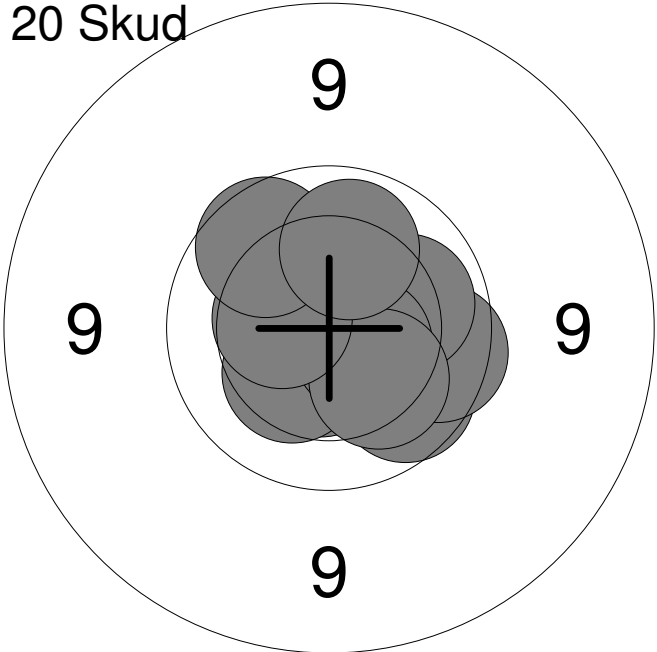
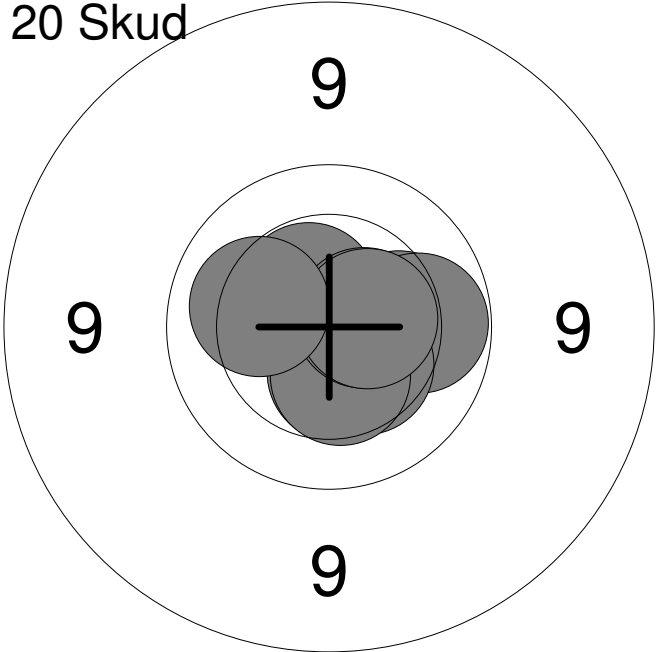
Hold	Skive	Lars Ørum Pedersen	
4	12		
15m	Aalborg Skyttekreds		1
28.02.2014	Nordjysk Mesterskab 2014, senio	Aalborg Skyttekreds	
Prøve		1: 9.9	↗
		2: 10.3	→
		3: 10.2	→
		4: 10.4	↗
		5: 10.2	→
		6: 9.9	↘
		7: 9.9	↘
		8: 10.5x	↘
		Serie	77.0
		Total	0.0
20 Skud		1: 9.9	↘
		2: 10.5x	↘
		3: 9.8	→
		4: 10.1	→
		5: 10.3	↘
		6: 10.5x	↘
		7: 10.2	↘
		8: 10.4	↗
		9: 9.9	↗
		10: 10.1	↗
		Serie	97.0
		Total	97.0
20 Skud		11: 10.5	↘
		12: 10.2	→
		13: 10.0	→
		14: 10.4	↘
		15: 10.9x	↗
		16: 10.5x	↗
		17: 10.4	↘
		18: 10.6x	→
		19: 10.5x	→
		20: 10.2	↖
		Serie	100.0
		Total	197.0

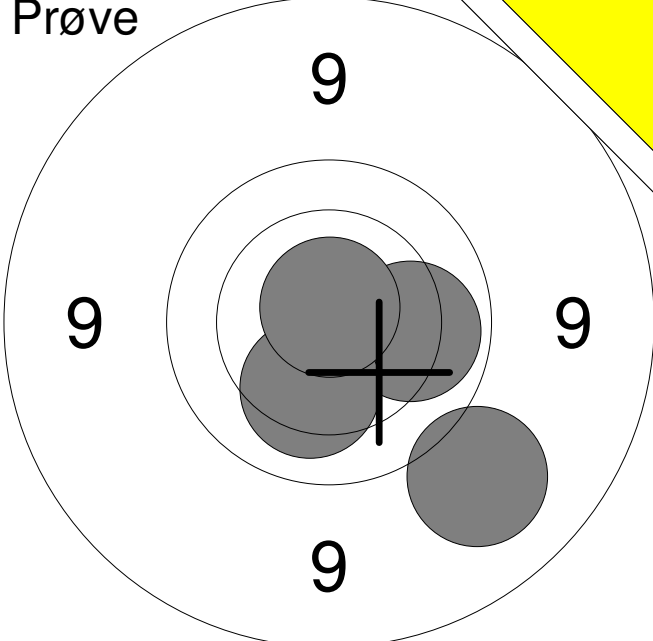
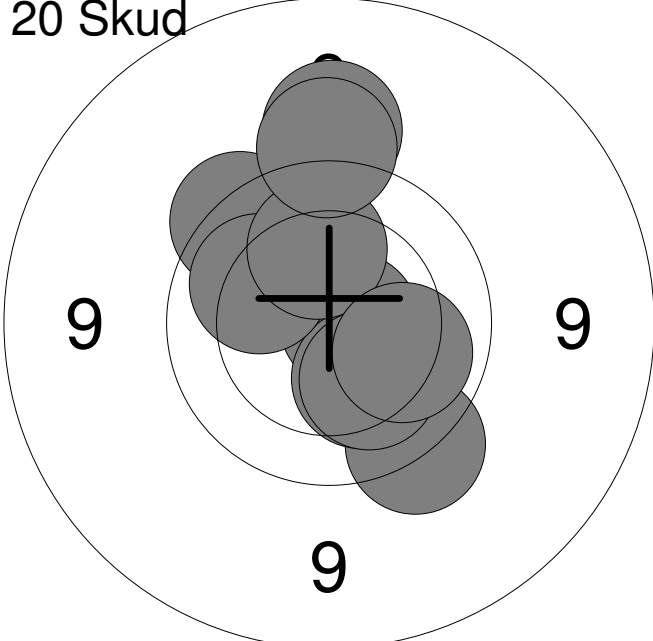
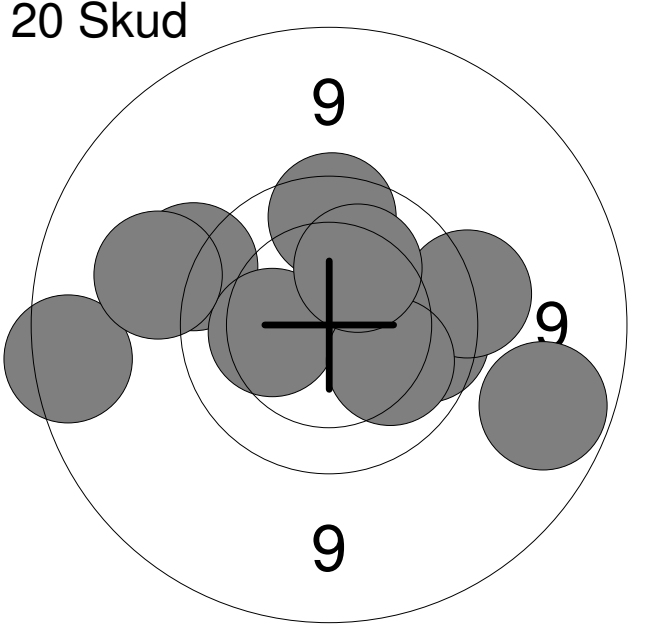
Hold	Skive	Egon Østergaard	
5	1	15m	Vester Han Herred Skytteforening M2
28.02.2014	Nordjysk Mesterskab 2014, senio	Aalborg Skyttekreds	
Prøve		1: 10.1 →	
		2: 10.2 ↓	
		3: 9.2 ↘	
		4: 10.8x ↑	
		Serie	39.0
		Total	0.0
20 Skud		1: 10.7x →	
		2: 9.6 ↓	
		3: 9.3 ↑	
		4: 9.7 ↗	
		5: 10.3 ↓	
		6: 10.1 ↗	
		7: 10.1 ↑	
		8: 9.4 ↑	
		9: 10.2 ↓	
		10: 10.1 →	
		Serie	96.0
		Total	96.0
20 Skud		11: 9.9 →	
		12: 9.0 →	
		13: 9.6 →	
		14: 9.5 ↗	
		15: 9.8 ↑	
		16: 10.3 ←	
		17: 10.1 ↓	
		18: 8.8 ←	
		19: 10.2 ↗	
		20: 9.3 ←	
		Serie	92.0
		Total	188.0

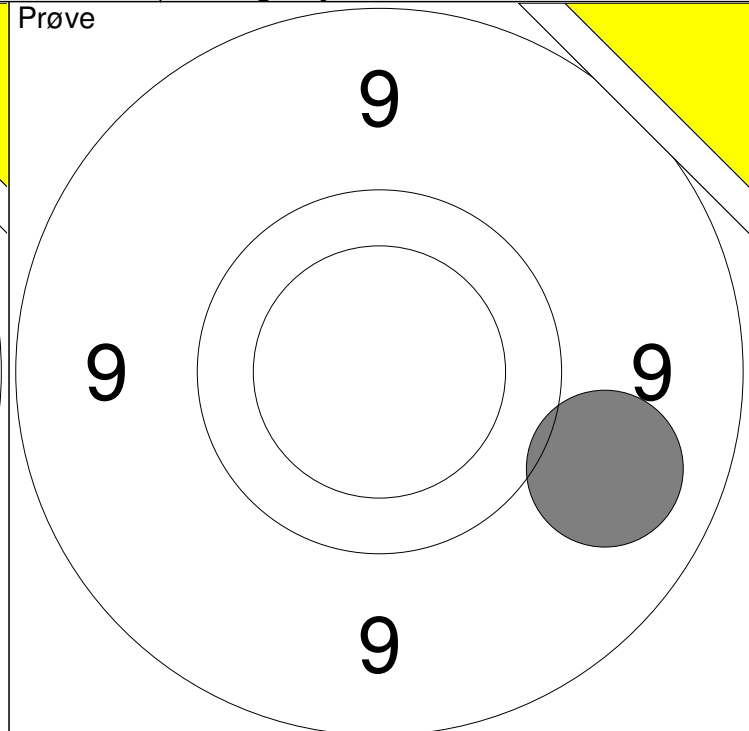
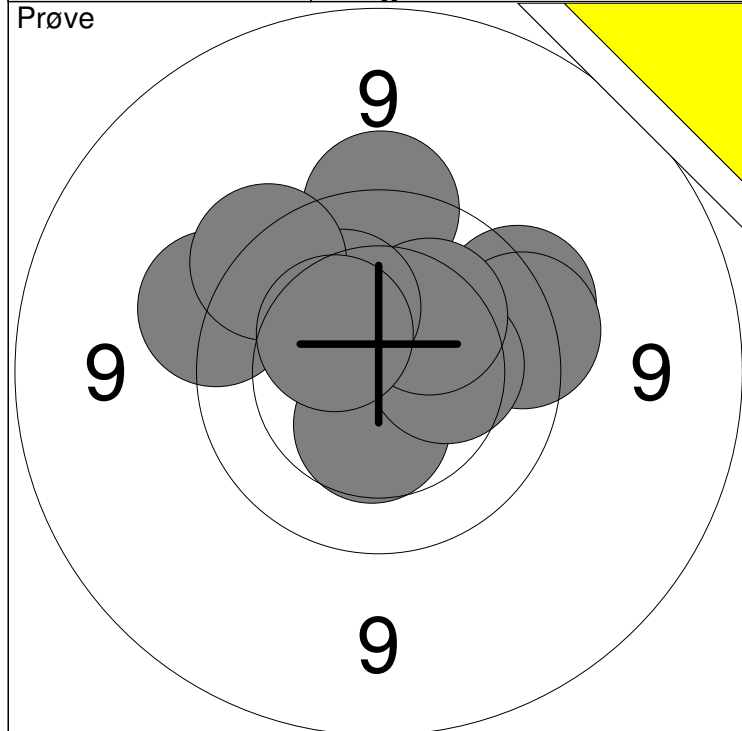

1: 9.6	↑	6: 10.2	↗	Serie	95
2: 10.4	↓	7: 9.6	↖		
3: 9.7	↗	8: 10.2	↗	Total	0
4: 9.7	→	9: 9.7	↗		
5: 10.3	→	10: 10.4	↗		

11: 9.2	→	Serie	9
		Total	0

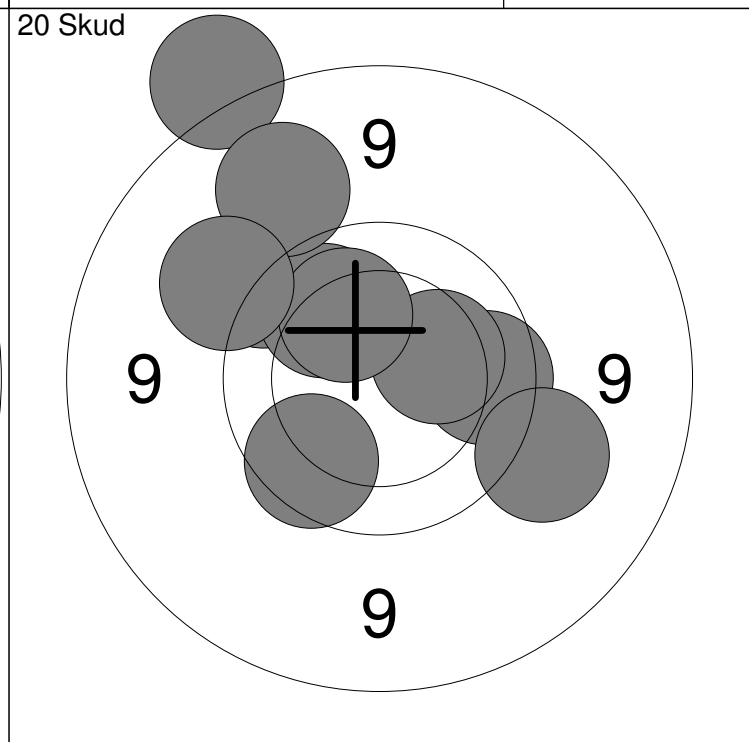
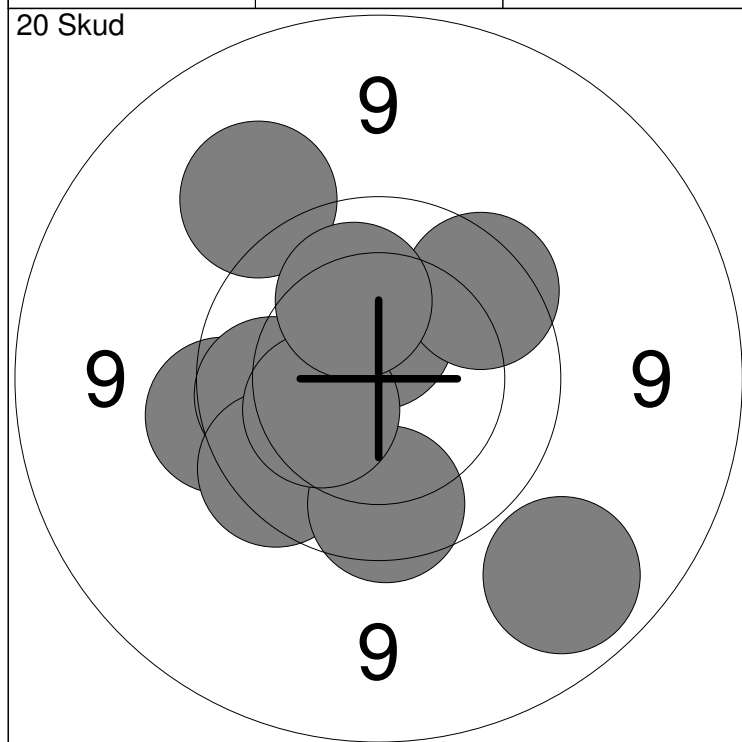

1: 9.6	←	6: 9.8	↖	Serie	93
2: 10.5x	↑	7: 9.8	↓		
3: 9.9	←	8: 9.8	↗	Total	93
4: 9.3	↗	9: 10.3	↖		
5: 9.0	↓	10: 10.2	↗		

11: 8.6	↗	16: 9.4	↘	Serie	92
12: 9.8	→	17: 9.2	↗		
13: 9.6	↗	18: 10.1	↗	Total	185
14: 10.0	↗	19: 9.8	↘		
15: 10.3	↗	20: 9.4	↖		

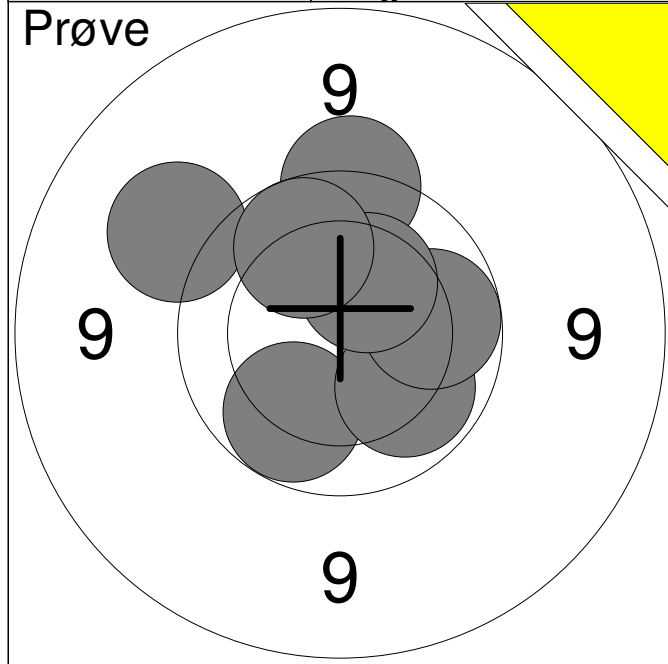

1:	10.0	↙
2:	10.0	↘
3:	10.0	→
4:	9.3	↗
5:	9.6	↑
6:	10.3	↗
7:	9.9	↗
Serie		67.0
Total		0.0

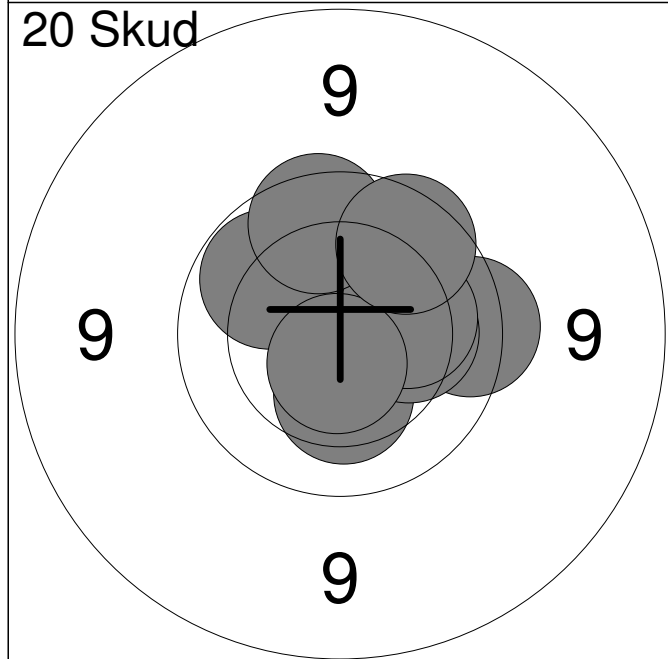

1:	10.3	↖
2:	9.7	→
3:	10.2	↑
4:	10.0	↗
5:	10.3	↓
6:	10.2	→
7:	10.2	→
8:	9.8	↑
9:	10.6x	↓
10:	9.8	↗
Serie		97.0
Total		97.0

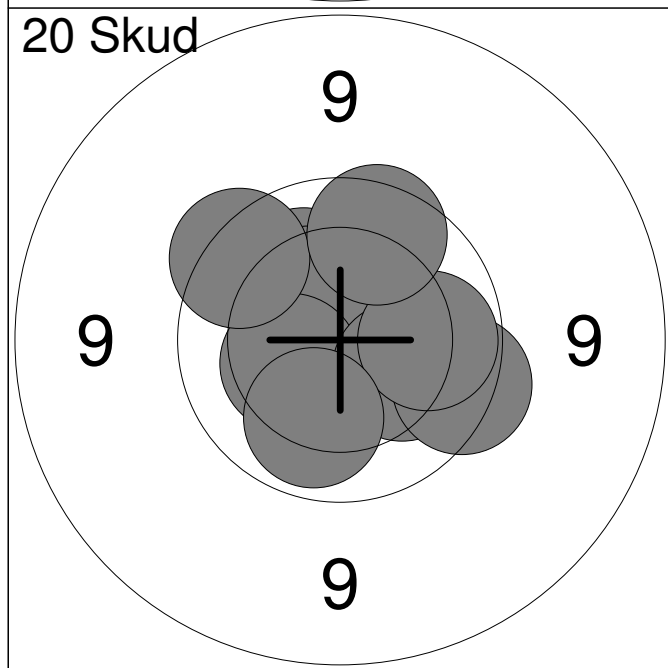

11:	10.3	↗
12:	10.2	↗
13:	10.4	↗
14:	10.4	↖
15:	10.2	↘
16:	9.7	↘
17:	9.7	↗
18:	10.0	→
19:	10.1	↓
20:	9.8	↑
Serie		97.0
Total		194.0

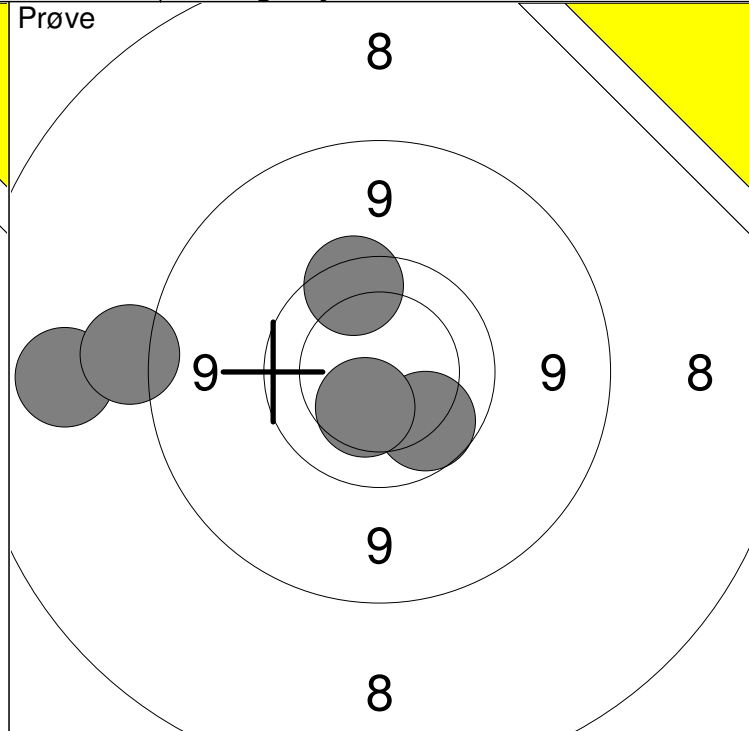
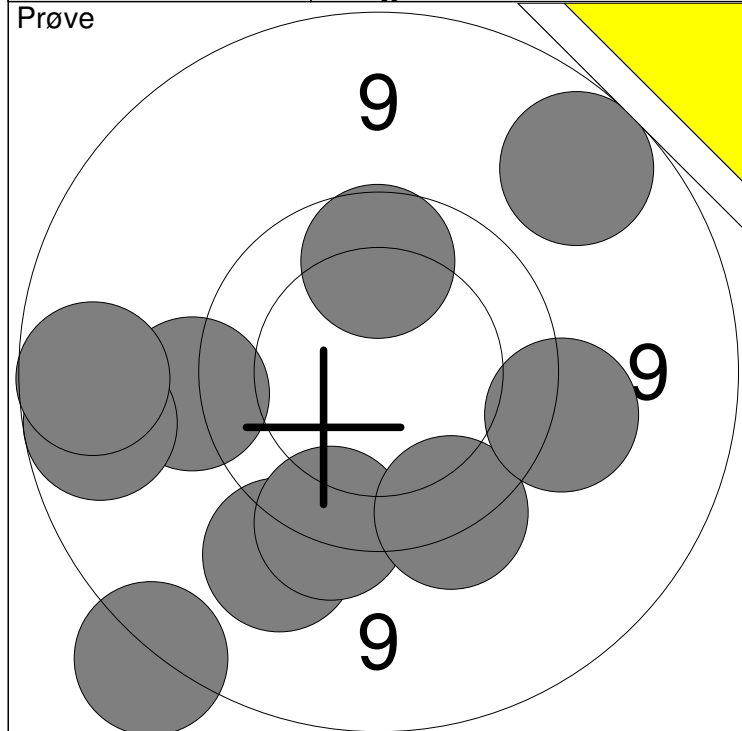

1: 9.4 ↘	6: 9.6 ↘	Serie 86
2: 9.5 ←	7: 9.6 ↘	
3: 8.6 ↘	8: 8.9 ↗	Total 0
4: 9.9 ↑	9: 8.9 ←	
5: 8.9 ←	10: 9.5 →	

11: 9.9 ↘	Serie 44
12: 8.2 ←	
13: 8.6 ←	Total 0
14: 9.7 ↑	
15: 10.4 ↘	

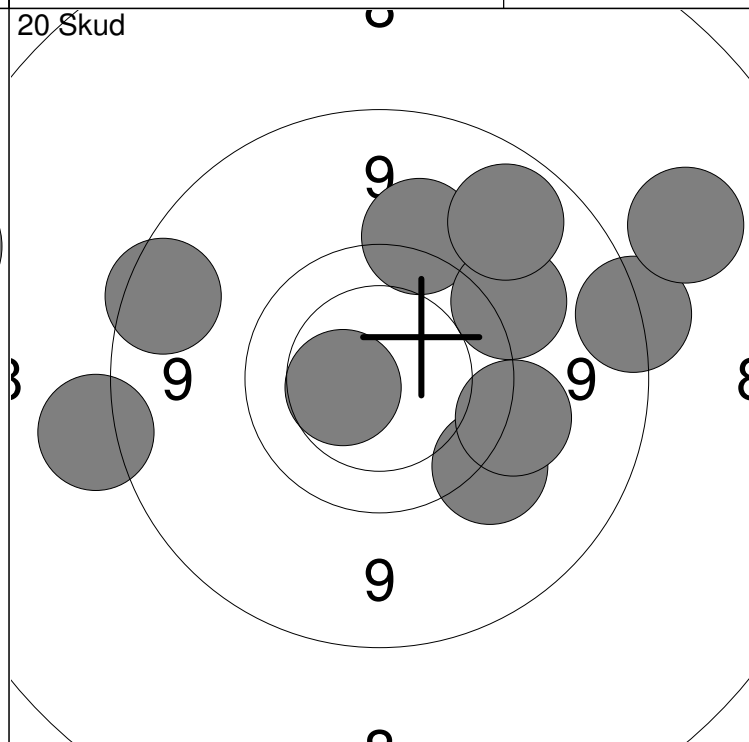
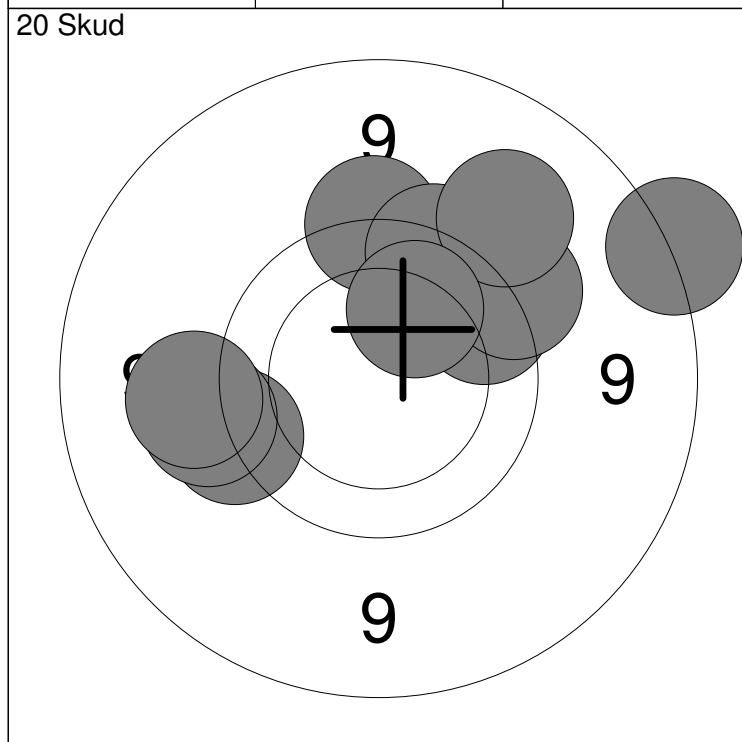

1: 9.6 ↑	6: 9.7 ↗	Serie 90
2: 9.5 ←	7: 9.5 ↗	
3: 9.4 ←	8: 9.2 ↗	Total 90
4: 9.4 ←	9: 8.6 ↗	
5: 9.7 ↑	10: 10.1 ↑	

11: 8.6 ←	16: 8.7 →	Serie 87
12: 8.9 ←	17: 8.3 ↗	
13: 9.5 ↘	18: 9.4 ↗	Total 177
14: 10.5 ←	19: 9.5 →	
15: 9.4 ↑	20: 9.0 ↗	

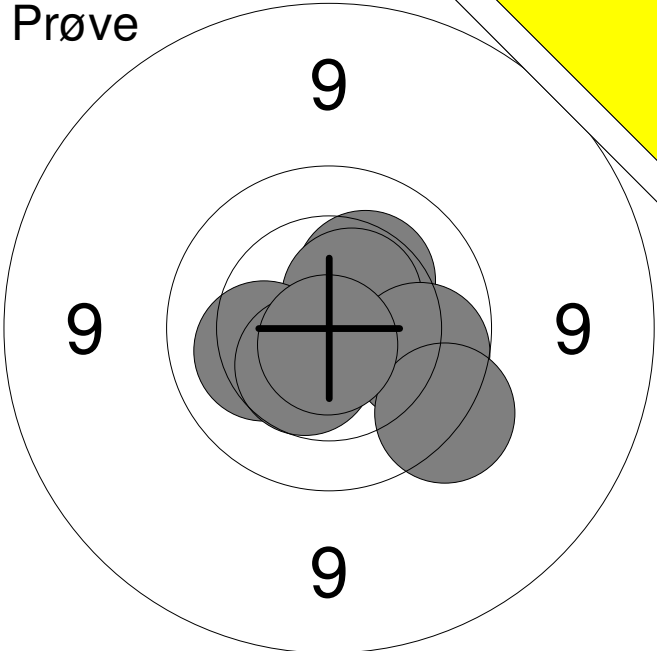
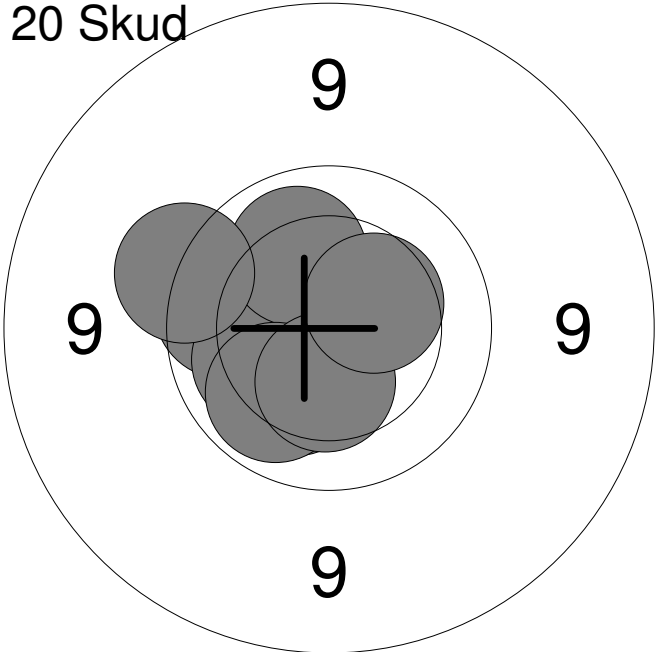
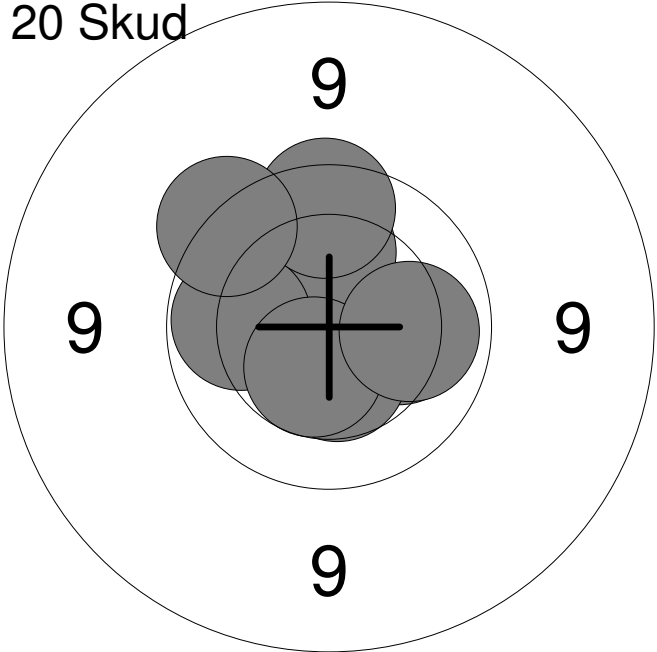
Hold	Skive	Henrik Frankfurth	
5	11		
15m	Aalborg Skyttekreds	M1	
28.02.2014	Nordjysk Mesterskab 2014, senio	Aalborg Skyttekreds	
Prøve		1: 10.3 ↗	
		2: 10.5x ↗	
		3: 10.2 ←	
		4: 9.9 →	
		5: 9.6 ↘	
		6: 10.5 ↙	
		7: 10.8x ↓	
		Serie	68.0
		Total	0.0
20 Skud		1: 10.2 ↙	
		2: 10.5 ←	
		3: 9.9 ←	
		4: 10.8x ←	
		5: 10.1 ←	
		6: 10.1 ↗	
		7: 10.0 ↙	
		8: 9.6 ←	
		9: 10.4 ↓	
		10: 10.4 ↗	
		Serie	98.0
		Total	98.0
20 Skud		11: 10.6x →	
		12: 10.7x ←	
		13: 10.2 →	
		14: 10.5 ↓	
		15: 10.1 ↑	
		16: 10.0 ←	
		17: 10.5 ↙	
		18: 9.8 ↑	
		19: 10.1 →	
		20: 9.6 ↗	
		Serie	98.0
		Total	196.0

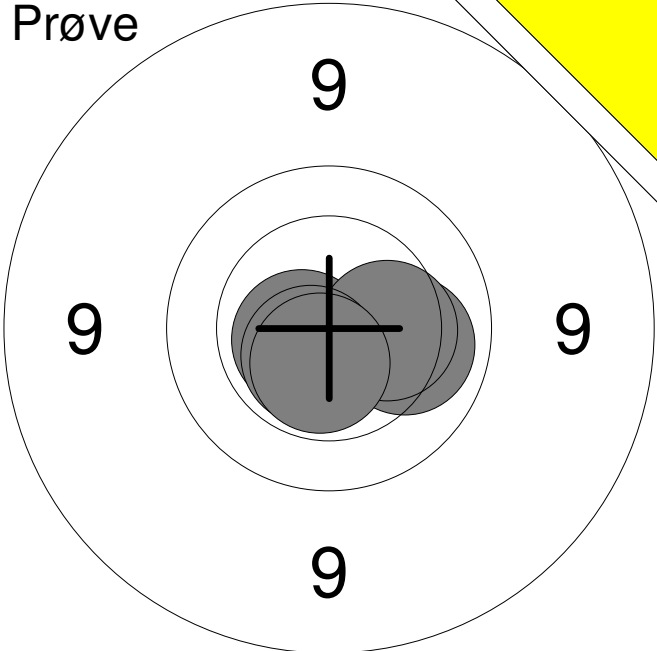
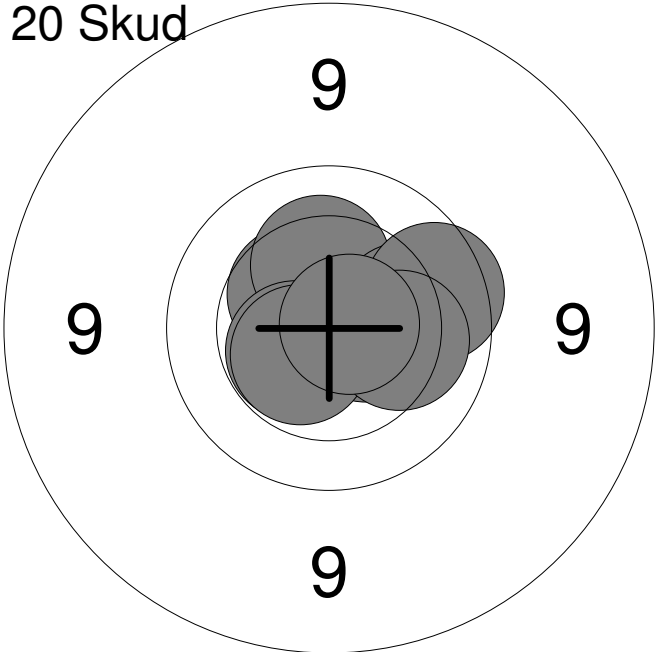
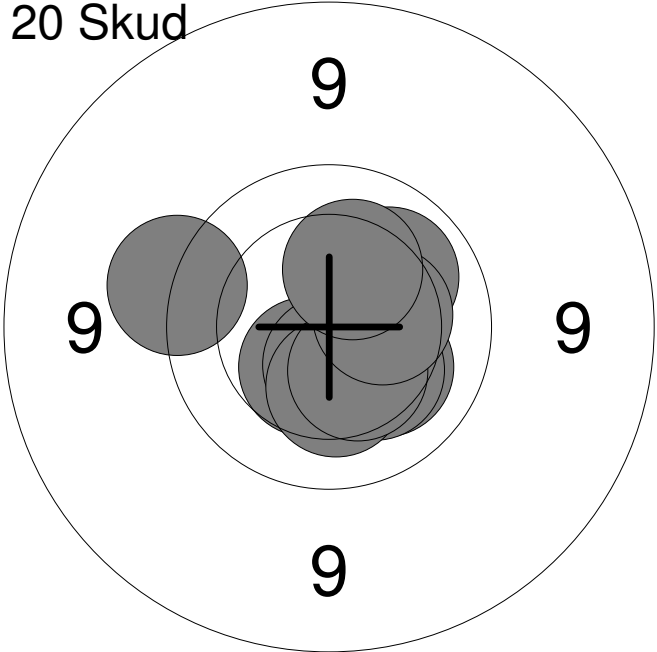
Hold	Skive	Lars Ørum Pedersen	
5	12		
15m	Aalborg Skyttekreds	M1	
28.02.2014	Nordjysk Mesterskab 2014, senio	Aalborg Skyttekreds	
Prøve		1: 10.6x ↙	
		2: 10.1 →	
		3: 10.3 →	
		4: 10.6x ↙	
		5: 10.6x ↓	
	Serie	50.0	
	Total	0.0	
20 Skud		1: 10.7x ↗	
		2: 10.5 ↗	
		3: 10.6x →	
		4: 10.3 ↑	
		5: 10.1 →	
		6: 9.8 →	
		7: 10.5x ↙	
		8: 10.5x ↙	
		9: 10.2 →	
		10: 10.7x →	
	Serie	99.0	
	Total	99.0	
20 Skud		11: 10.2 ↓	
		12: 10.3 ↓	
		13: 10.5 ↙	
		14: 10.5x ↓	
		15: 10.3 ↓	
		16: 9.5 ↖	
		17: 10.1 ↗	
		18: 10.4 ↙	
		19: 10.4 →	
		20: 10.3 ↑	
	Serie	99.0	
	Total	198.0	